



RENAULT
Passion for life

New
Renault MEGANE R.S.





Motorsports in its genes

New Renault MEGANE R.S. is an impressive car. A car built to arouse your driving instincts with wings extended by 60 cm, special bumpers featuring a Formula 1 blade at the front and a wide diffuser at the rear. Sitting squarely on its 19-inch black diamond alloy wheels, the front end features LED lights with the additional multi-reflector R.S. Vision system. It includes a central exhaust exit, side extractor vents and a wide lip spoiler with exclusive Orange Tonic bodywork colour, New Renault MEGANE R.S. is clearly designed for sporting performance.









A sport cockpit

As soon as you see the interior - carbon grey with touches of red - you want to get behind the wheel. New Renault MEGANE R.S. invites you to take to the road, with Alcantara leather bucket seats designed for support, a leather steering wheel and personalisable dashboard. At the same time, the aluminium pedal assembly take you into a new dimension, the world of R.S. sporting performance.





A passion for motorsports spanning 40 years

Leaders in motorsports for 40 years, our engineers trialled the solutions featured on New Renault MEGANE R.S on the track. Building on the infinite legacy of an exceptional championship, through efficiency, braking quality, reinforced roadholding and powertrain reliability, steering wheel paddles and launch control!



Nico Hülkenberg,
Pilot Renault Sport Formula One™ Team





1.

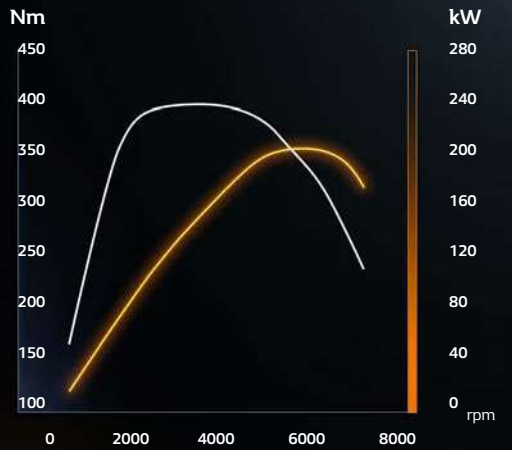

Power: 280hp/205kw at 6,000rpm/min

Max. torque: 390Nm at 2,400rpm

4-cylinder engine

1.8 litre (1,798cm³)



Efficiency and performance

New Renault MEGANE R.S. benefits from the know-how of Renault Sport in adapting motorsports technologies to production sports vehicles. It features in-car equipment on a par with the best in class and a range of driving aids for any type of road and any situation.

Suspension with hydraulic compression stops: With the addition of hydraulic compression stops, the shock absorbers absorb impact better. This technology delivers spectacular results in terms of progressive control, comfort and performance.

Sporty and reliable

With its many driving aids, New Renault MEGANE R.S. allies sporting performance with safety. It also features parking sensors, overspeed warning, emergency braking assistance and hands free parking with reverse camera. An impressive pedigree!

1. R.S. Vision: groups the side lights, long-range headlights, fog lights and cornering lights, as part of a high-performance lighting package.

2. Blind spot warning: uses sensors on either side of the front and rear bumpers to warn you of a vehicle entering its range.



Race mode, aim for pole position

Use R.S. Drive to select your driving mode (Normal, Sport and Race) and adapt the gearbox mapping, ESP behaviour, steering and sensitivity of the accelerator pedal. Play with the paddles to change gears at ultra-fast speed. Enjoy the excitement of a Grand Prix start with Launch Control: left foot on the brake, right foot on the accelerator. Just release the brake pedal for a breathtaking rush of adrenalin.

Launch control





Agility and Stability

4CONTROL 4WD technology contributes to incisive steering and optimised roadholding for a precise, surefooted drive. At low speeds, the system turns the rear wheels in the opposite direction to the front wheels. At speeds of over 60 kph (100 km/h in Race mode), all four wheels turn in the same direction. You are in control of the road.

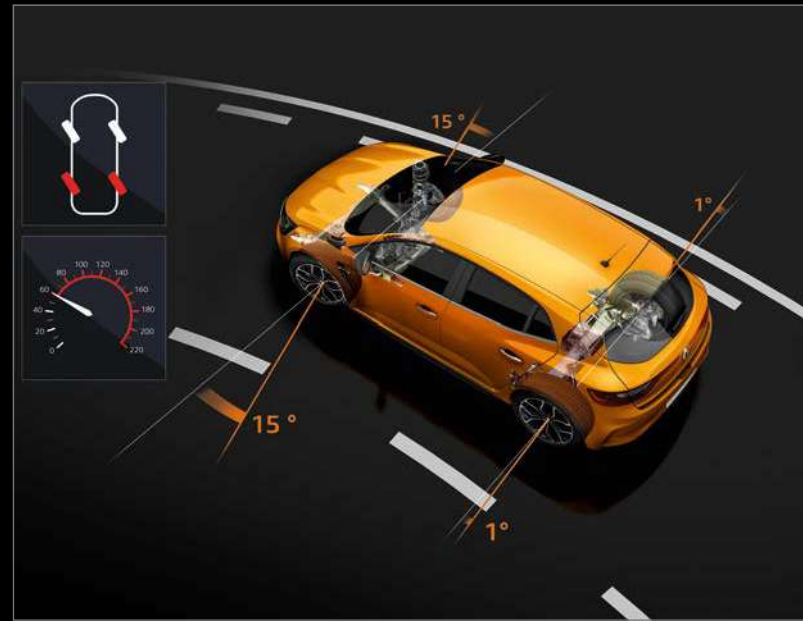
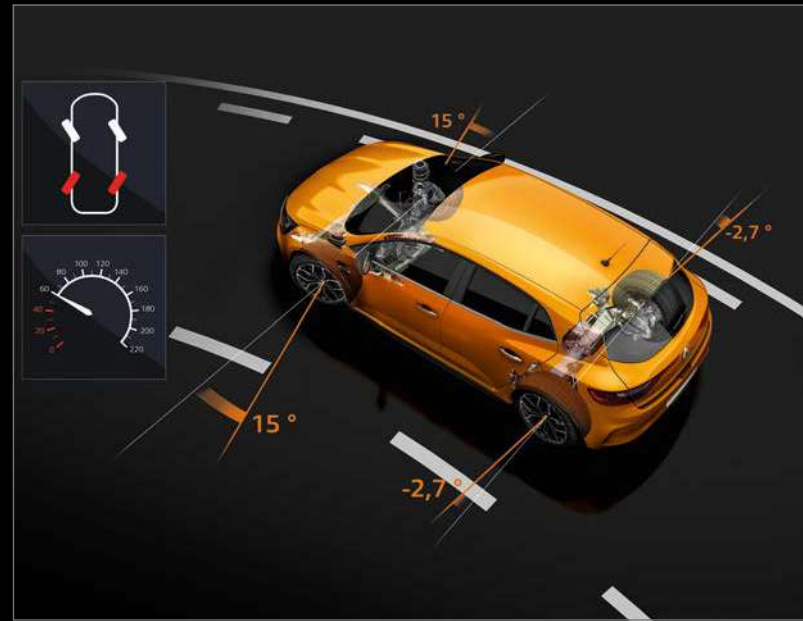





Display, analyse and share your performance

Your driving talents deserve to be recognised, stored and analysed! The onboard R.S. Monitor stores your driving settings in real time on the R-LINK2 screen.

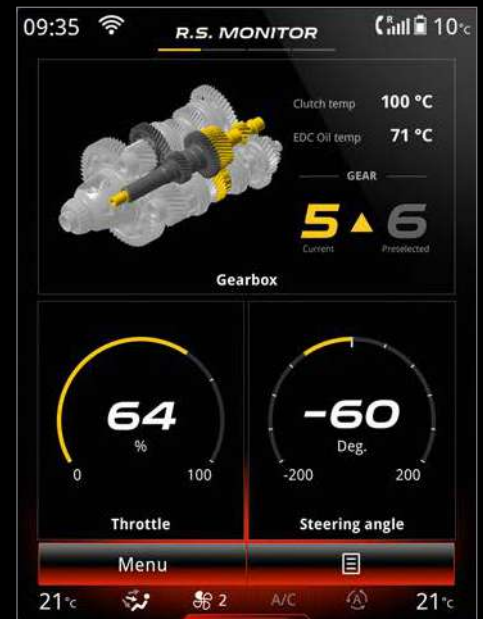

4-cylinder engine
1,81 - 280 hp / 390 Nm

R.S. Monitor

R.S. Vision

Front double-axis
strut system

4 hydraulic
compression stops

4CONTROL

EDC dual clutch

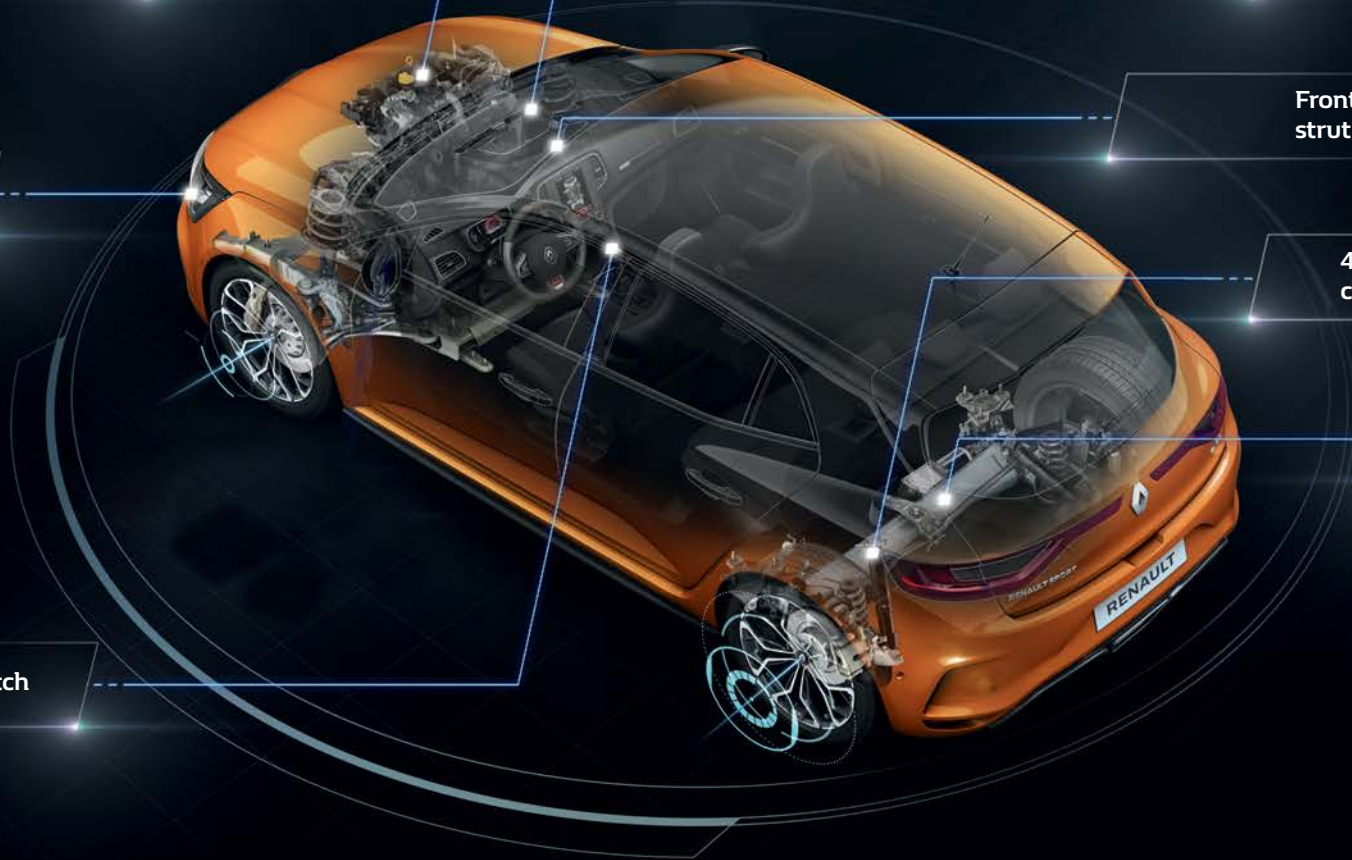

CARLAB Chromo Zone

Tonic Orange

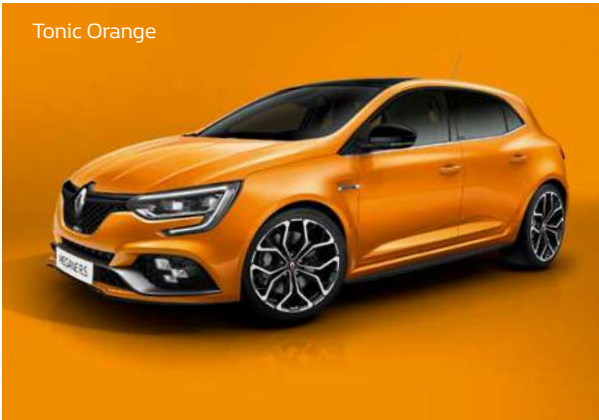

Sirius Yellow

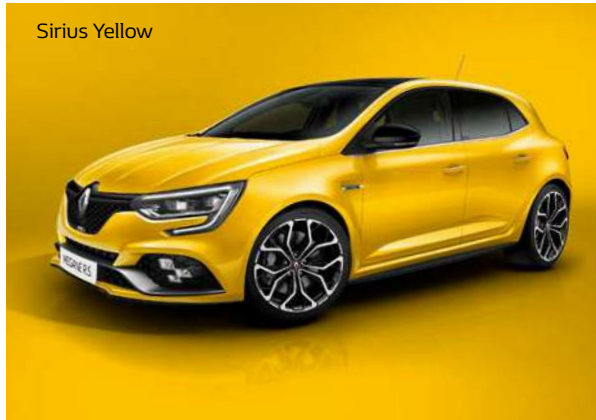

Flame Red



Mercury



Comet Grey



Pearl White



Starry Black





Options:

- Panoramic sunroof + autodimming rearview mirror
- R.S. Monitor
- Premium pack:
 - Dark and red rs alcantara trim.
 - R-link 2 - 8.7" Touchscreen with navigation
 - Bose soundsystem, 8 speakers, 2 usb, aux, bluetooth

Standard equipment

- | | | | |
|---|--|---|--|
| <ul style="list-style-type: none"> • Front side airbags + Front & rear curtain airbags • Antilock Braking System • Emergency brake assist • Driver and passenger front airbags • Disconnectable passenger airbag • Seatbelt reminder for Driver + front passenger + 3 rear passengers • Engine electronic immobilizer • Adjustable L-shape rear headrests • Height adjustable front headrests • Height adjustable front seatbelts • Three 3-point rear seatbelts • Tyre pressure monitoring • ESP with Hill Start Assist • Electric parking brake • ISOFIX child seat mounting points • 1-touch triple turn signal on door mirrors • C-shape LED DRLs • Rear high mounted LED brake light | <ul style="list-style-type: none"> • Full LED headlights • RS Vision: long range light beams with integrated signature • Manual day/night dimming room mirror • 4CONTROL 4 wheel-steering technology • Automatic headlamps and rainsensing wipers • Power heated door mirrors with temperature sensors, power foldable • Smoker accessories • Eco advice with gear shift indicator • Dual zone auto air conditioning + rear air ducts (under front seats) + rear air-vents • Black paddles shift behind steering wheel • Specific suspensions with RS tuning • Central door locking • High central console (with sliding armrest / storage / double cup holder) • Rear glass with demister • Rear one-touch power windows | <ul style="list-style-type: none"> • Front one-touch power windows • Multi-sense with variable engine performance, sound, steering, throttle and variable damping • Welcome/goodbye sequence (approach detection, exterior lights & door mirrors activation and interior ambient lighting) • Rear 12V power outlet • Driver & Passenger sunvisors with mirrors + illumination • R-Link 2 - 7" touchscreen, navigation, 3D Sound by Arkamys, 8 speakers, • 2 USBs, AUX, streaming via Bluetooth • Cruise control with speed limiter • Renault Smart Card with walk away closing with specific Renault Sport design + Push button start • 7" colour TFT combimeter with ambient lighting and customisable skins/ colours • Light tinted anti-glare windows | <ul style="list-style-type: none"> • RS Dark fabric trim • RS Dark interior harmony • 1/3 -2/3 folding rear seats + central armrest and 2 cupholders • Manual front seats adjustment with Driver height & lumbar adjust • Sport rear spoiler • Temporary spare wheel • Blind Spot Warning • Hands free parking + Rear Camera + Front & Rear parking sensors • 19" Black diamond alloy wheels • RS nappa leather steering wheel |
|---|--|---|--|

CARLAB Free Wheel

ENGINE

Type of engine (injection/turbo)	4 cylinders with direct turbo injection
Capacity (cm ³)	1,798
Bore x stroke (mm)	79.7 x 90.1
Number of valves	16
Max. power kW EEC (hp) at engine speed of (rpm)	205kW (280hp) at 6000rpm
Max. torque Nm EEC (m.kg) with revs of (rpm)	390Nm from 2400rpm to 4800rpm
Distribution type	By chain
Stop & Start and energy recovery from braking	Yes

GEARBOX

Gearbox type	Dual-clutch EDC automatic gearbox
Number of gears	6

PERFORMANCE

Aerodynamics CdA (m ²)	0.78
Top speed (km/h)	250
400 m stopping distance (s)	14
1,000m stopping distance (s)	25
0-100 km/h (s)	5.8

CONSUMPTION AND EMISSIONS

Extra-urban cycle (l/100 km)	6.1
Combined cycle (l/100 km)	7
Urban cycle (l/100 km)	8.5
CO ₂ combined cycle (g/km)	158
Fuel tank capacity (L)	50

CHASSIS – STEERING AND AXLES

Electric power steering	Yes
R-EPS mechanical steering system and electrically assisted steering rack	Yes
Turning circle, kerb to kerb (m at 5 km/h)	10.3

BRAKING

Front: ventilated disc Ø (mm)	355
Rear: solid disc Ø (mm)	290
Emergency brake assist	Yes
Electronic stability control - ESC	Yes

WHEELS AND TYRES

Wheels	19"
Standard tyre size	245/35 R19
Drive wheels	4

WEIGHT (KG)

Unladen kerb weight (MIN)	1,430
Gross vehicle weight (GVW)	1,930
Gross train weight (GTW)	1,930
Max. weight on roof (kg)	80

CARLAB Wheel Rims



19" Interlagos black diamond alloy wheels

CARLAB Dimensions

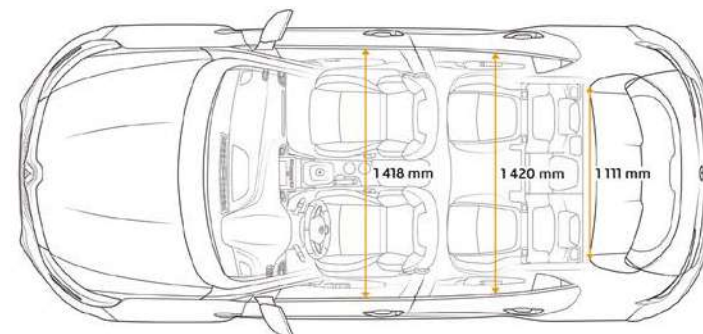
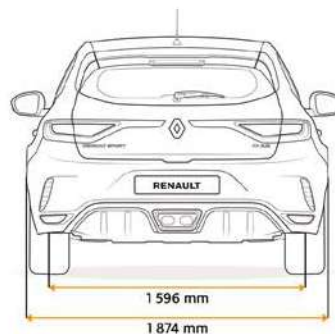
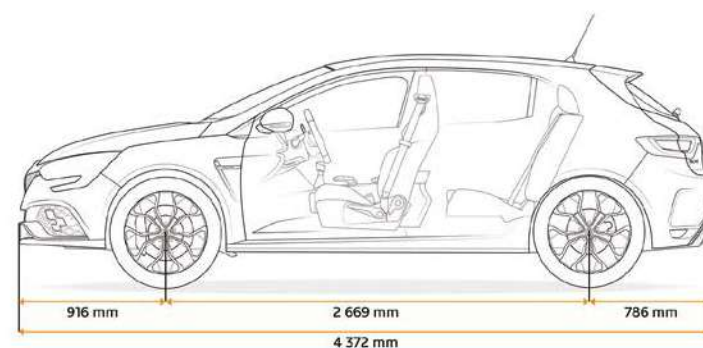
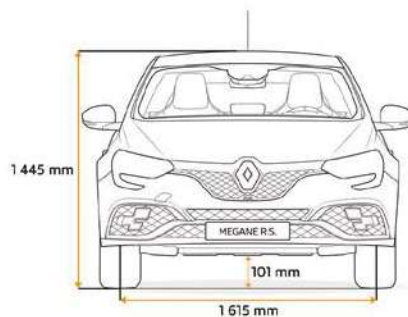



MEGANE R.S.



New Renault MEGANE R.S.

Conquer every corner

Continue the Renault Megane R.S. experience

on www.renault-me.com

Join us on     /RenaultME

Every precaution was taken to ensure this publication was accurate and up-to-date when printed. This document is based on pre-production and prototype models. In line with its policy of continuous product improvement, Renault reserves the right to modify the specifications, vehicles and accessories described and featured at any time. Any such changes are communicated to Renault dealers as quickly as possible. Depending on the country of sale, some versions may differ and some equipment may be unavailable (as standard, as an option or as an accessory). Please contact your nearest dealer for the latest information. For technical printing reasons, the colours featured in this document may differ slightly from those of the actual paintwork or interior trim. All rights reserved. Reproduction in any format and by any means of all or part of this publication is prohibited without prior written authorisation from Renault.

Renault recommends 

 Prodigious

Photo credits: T. Klinkow, A. Bernier, © Renault Marketing 3D-Commerce – Printed in EC – xxxxxxxxxx – September 2018.

Renault s.a.s. French simplified joint-stock company with capital of €533,941,113.00 / 13-15, quai Le Gallo – 92100 Boulogne-Billancourt Cedex – Nanterre Trade & Companies Registry Nanterre B 780 129 987 / Tel.: +33 (0) 810 40 50 60