



# A6

Audi A6 Saloon | A6 Avant | A6 allroad quattro

■ Audi S6 Saloon | S6 Avant

Vorsprung durch Technik **Audi** 



**Dialogue: Audi QR codes**

Experience Audi even more directly: download a QR app to your smartphone and then scan the QR code or follow the given link in your browser.



	Page		
<b>Fascination</b>			
	4 Audi A6 Saloon and A6 Avant	18 Audi A6 allroad quattro	26 Audi S6 Saloon and S6 Avant
<b>Technology</b>			
	36 Innovations	42 quattro®	48 Assistance systems
	38 Audi ultra	44 Intelligent performance	50 Simplicity
	40 Audi connect	46 Dynamics	52 Audi Matrix LED headlights
<b>Equipment</b>			
	56 Style guides	72 Audi exclusive	87 Design
	60 S models	74 Paint finishes	88 Steering wheels/controls
	62 Audi ultra	76 Wheels/tyres	89 Comfort
	64 Engines	78 Seats/seat upholstery	91 Infotainment
	66 S line	82 Headlinings	95 Assistance systems
	68 Audi design selection	84 Inlays	97 Technology/safety
	70 Audi exclusive line	86 Lights	99 Audi Extended Warranty
<b>Other</b>			
	100 Audi Genuine Accessories	110 Dimensions	124 The fascination of Audi
	104 Technical data	114 Index	

The equipment for the vehicles illustrated in the Fascination section can be found on page 123. The fuel consumption and CO<sub>2</sub> emission figures can be found from page 104 onwards.

## Fascination comes through in many facets.

Innovative technologies. Progressive design. And a thrilling wide range of equipment. The new Audi A6 Saloon and the new Audi A6 Avant combine these values within an extraordinary symbiosis of sportiness and elegance. And open up a wide range of possibilities for pioneering mobility. Discover your way.

The fuel consumption and CO<sub>2</sub> emission figures can be found from page 104 onwards.

# A6

Audi A6 Saloon | A6 Avant



## Dynamic design revealed in every line.

A saloon that will fascinate you at first glance. Emotionally stirring. Forward thrust made visible. A design that exudes progress and sportiness all along the line.

Take the tornado line. Underneath the side windows it extends from the headlights to the rear. The horizontal orientation of all lines give the vehicle an even wider and sportier appearance at front and rear.



The fuel consumption and CO<sub>2</sub> emission figures can be found from page 104 onwards.



Sportiness meets elegance. Functionality meets comfort. The A6 Avant demonstrates an ideal balance of versatility. Light, elegantly flowing proportions and a precisely defined body line. An independent silhouette. Unmistakeable high shoulder, narrow window band and shaped side sills. Elegantly rounded off by a coupé-like roof line.

The fuel consumption and CO<sub>2</sub> emission figures can be found from page 104 onwards.





Progressive design and innovative brilliance. Among other things, with near daylight illumination of the road. The LED headlights available on request turn night into day.

Impressive in any light conditions: the Audi Singleframe in three-dimensional design. Flat and wide. Exuding excellence. With horizontal chrome struts that impressively emphasise the dynamism of the A6.

The optional 20-inch forged aluminium wheels in 5-arm star design contrasting grey, partly polished\*. An expression of power – even when stationary.



To see the Audi A6 in action, just scan this QR code using your smartphone. Or follow this link in your browser: [www.audi.com/a6film](http://www.audi.com/a6film)

\*Please note the special information relating to wheels on page 109. The fuel consumption and CO<sub>2</sub> emission figures can be found from page 104 onwards.



## Excellence shines through, strictly geared towards the driver.

An impressive sense of space combined with a comfort-oriented interior design. Special details in the A6 Saloon and A6 Avant ensure the highest exclusivity. On request with MMI navigation plus with MMI touch. The latest generation of Audi infotainment. With a large 8-inch TFT colour display. A wide range of functions and Audi connect services integrated in a user-friendly manner.

Including impressive sound quality. In every seat. Thanks to the Bose surround sound system. With 14 loudspeakers and a total output of more than 600 watts. Brilliant sound. Evenly distributed in the vehicle. Unmistakeable. And noticeable. Thanks to subwoofers with a powerful bass reproduction.

The fuel consumption and CO<sub>2</sub> emission figures can be found from page 104 onwards.

## Generous comfort that you can feel.

Space and comfort generously designed. With numerous storage spaces and practical stowing options. Making every trip a relaxing pleasure.

Comfortable functionality. For example, when folding the rear seat backrest 40:60, using the convenient remote backrest unlocking function from the luggage compartment. The luggage compartment volume provides 565 litres of space. And with the rear seats fully folded down this increases to 1,680 litres.

As an option, the luggage compartment lid opens and closes electrically. With the optional convenience key with sensor-controlled release of luggage compartment lid a corresponding foot movement is sufficient. The opening angle can be custom programmed. The luggage compartment cover automatically retracts when the tailgate is opened, giving you easy access to the luggage compartment. When the tailgate is closed it automatically extends again.



The fuel consumption and CO<sub>2</sub> emission figures can be found from page 104 onwards.





## Convincing performance is revealed in an efficient drive.

Excellent dynamics and outstanding efficiency. Produced by highly efficient TFSI and TDI engines. With an impressive torque performance and thrilling acceleration values.

Thanks to innovative efficiency technology, fuel consumption and emissions are reduced. For example, the more sophisticated start-stop system automatically switches off the engine in stationary phases. And even during the stopping process. Audi drive select provides the highest efficiency while driving. As standard. With five modes that ensure an individual vehicle adjustment. From comfortable to sporty. Particularly energy-saving in the efficiency mode. In combination with S tronic including coasting mode, which switches to neutral early on when you release the accelerator.

On request, the A6 Saloon and the A6 Avant are also available with quattro permanent  wheel drive. For even more traction and excellent handling when cornering. In conjunction with the improved optional sport differential, quattro raises the level of dynamics, agility and directional stability to new heights.

The fuel consumption and CO<sub>2</sub> emission figures can be found from page 104 onwards.





## The most attractive way of going your own way.

Why only use the same beaten tracks as everyone else? In the Audi A6 allroad quattro you have found a vehicle you can use to discover new roads for yourself and master challenges. Among other things, thanks to adaptive air suspension. The electronically controlled air suspension system with infinitely adjustable damping automatically adapts the suspension to the respective driving situation.

Wherever your inspiration may take you – the new A6 allroad quattro will get you to your destination in style. With high-performance and efficient TFSI and TDI engines. A spacious interior and plenty of luggage space. And the reassurance that you are always on the right track.

The fuel consumption and CO<sub>2</sub> emission figures can be found from page 104 onwards.

# A6

Audi A6 allroad quattro



## The most individual way of going your own way.

Unmistakeably an A6 Avant, even more unmistakably an A6 allroad quattro. Apparent at first sight. Thanks to the streamlined body line and wheel arch extensions. And the striking Singleframe in aluminium look: characteristic with vertical struts in chrome. A fascinating front view. Particularly in combination with the optional Audi Matrix LED headlights. In addition,

underbody protection that covers the entire width of the bumper. The roof edge spoiler and roof rails with high webs highlight the independent appearance. And if you also want to go your own way with respect to colour: the paint variant Java brown is available exclusively for the A6 allroad quattro.

The fuel consumption and CO<sub>2</sub> emission figures can be found from page 104 onwards.





In the Audi A6 allroad quattro, you are greeted by a truly special atmosphere. Characterised by generosity and exclusivity. Coupled with details that will fascinate you. Such as the optionally available sport seats in leather, Atlas beige with contrasting stitching that will give you excellent support. Or the optional inlays in aluminium delta, bronze that are exclusively available for the A6 allroad quattro. Same goes for the interior colour Santos brown or the Sierra cloth/mono.pur 350.

Keeping your eye on the way ahead. The standard tilt angle display shows you a graphic view of the vehicle on downhill or uphill gradients. Helping you to stay in control even when you are covering uneven ground. This is where the hill descent control assists you, allowing for a constant speed on downhill gradients. The Electronic Stabilisation Control (ESC) provides excellent directional stability. Of course, this is also the case on level ground or when driving uphill.

The fuel consumption and CO<sub>2</sub> emission figures can be found from page 104 onwards.

## The most powerful way of going your own way.

Power used intelligently. The powerful TFSI and TDI engines will win you over with their irresistible acceleration and astonishing efficiency. For example, through recuperation. During this process, energy that is released during braking or coasting is converted to electric energy. Stored in the battery, it is available for future acceleration. The aluminium hybrid design saves fuel, reduces emissions and makes the vehicle even more agile and is just as efficient.

Decisive for the sporty driving feel: the quattro permanent all-wheel drive. Optionally with the new improved sport differential that distributes variable amounts of power to each rear wheel. You can feel this in the impressive acceleration performance in corners. On almost any road. And even in bad weather.



To see the Audi A6 allroad quattro in action, just scan this QR code using your smartphone. Or follow this link in your browser: [www.audi.com/a6allroadfilm](http://www.audi.com/a6allroadfilm)

The fuel consumption and CO<sub>2</sub> emission figures can be found from page 104 onwards.





## Sophisticated sportiness.

The Audi S6 is so many things: a prestigious business car. An elite family car. An elegant, athletic vehicle for everyday use. No matter whether it's a Saloon or Avant – in every form it conveys intelligent power. And brings it to the road. Thanks to the powerful V8 TFSI engine with Audi cylinder on demand. Superb with quattro permanent all-wheel drive. And individual thanks to Audi drive select. Including efficiency. Among other things, due to the aluminium hybrid construction.

The fuel consumption and CO<sub>2</sub> emission figures can be found on page 108.

# S6

Audi S6 Saloon | S6 Avant



## A clear line requires one thing above all: lightness.

Elegant lightness. With a sporty interpretation for the road. Signalled by flat rear lights. And dynamic indicators with sequential luminous LED lights. Fascinating down to the last detail. New bumper design and inlays in chrome look on the tailgate. Typical S character. Emphasised by two chrome-plated twin tailpipe trims. Rear and roof edge spoilers dynamically round off the look.



The fuel consumption and CO<sub>2</sub> emission figures can be found on page 108.



## Unmistakeably progressive – up close and at a distance.

Progressive seen in a whole new light. The LED headlights combine trend-setting charisma with a high illumination. Even more brilliance if requested. With the Audi Matrix LED headlights. Including innovative functions that make driving at night even safer and more comfortable. See and be seen. The same applies to the exterior mirrors in attractive aluminium look. LED indicators integrated elegantly. S-typical at first sight: the striking Singleframe. With horizontal double chrome struts and S emblem. What gives the S6 its unmistakable character are the many details. Unmissable.







## Powerful performance requires control. And inner calm.

It's all at your command. Radio and driver information system, phone and navigation. Easily controllable via the multifunction sport leather steering wheel. With shift paddles in aluminium look. Ergonomic and sporty at the same time. With the MMI navigation plus with MMI touch the latest generation of infotainment is optionally available. Including tough-sensitive touch pads for fast and intuitive operation. For example, browse through the albums in your music collection on the jukebox with a swipe of the

finger or "write" your navigation destination directly on the control panel.

Lean back and enjoy. In top-quality sport seats in Alcantara/leather. With high seating comfort and good lateral support. On request with exclusive S sport seats in Valcona leather with even more distinctively shaped side bolsters. And integrated head restraints with S6 emblem.



The fuel consumption and CO<sub>2</sub> emission figures can be found on page 108.



## Efficiency: the art of reducing without losing out.

Fascinating facts: V8 4.0 TFSI engine with 331 kW. From 0 to 100 km/h in 4.4 seconds. Dynamic power build-up due to a high torque output. 550 Nm. And with almost 5% fewer CO<sub>2</sub> emissions compared to the previous model. Thanks to efficiency technologies, such as Audi cylinder on demand, the optimised start-stop system and recuperation. Greater power output, lower fuel consumption. See for yourself – with an extraordinary vehicle: the Audi S6.

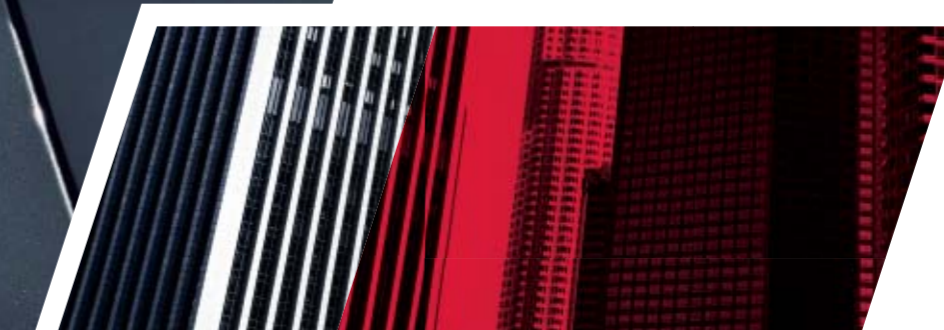

To see the Audi A6 in action, just scan this QR code using your smartphone. Or follow this link in your browser: [www.audi.com/s6film](http://www.audi.com/s6film)

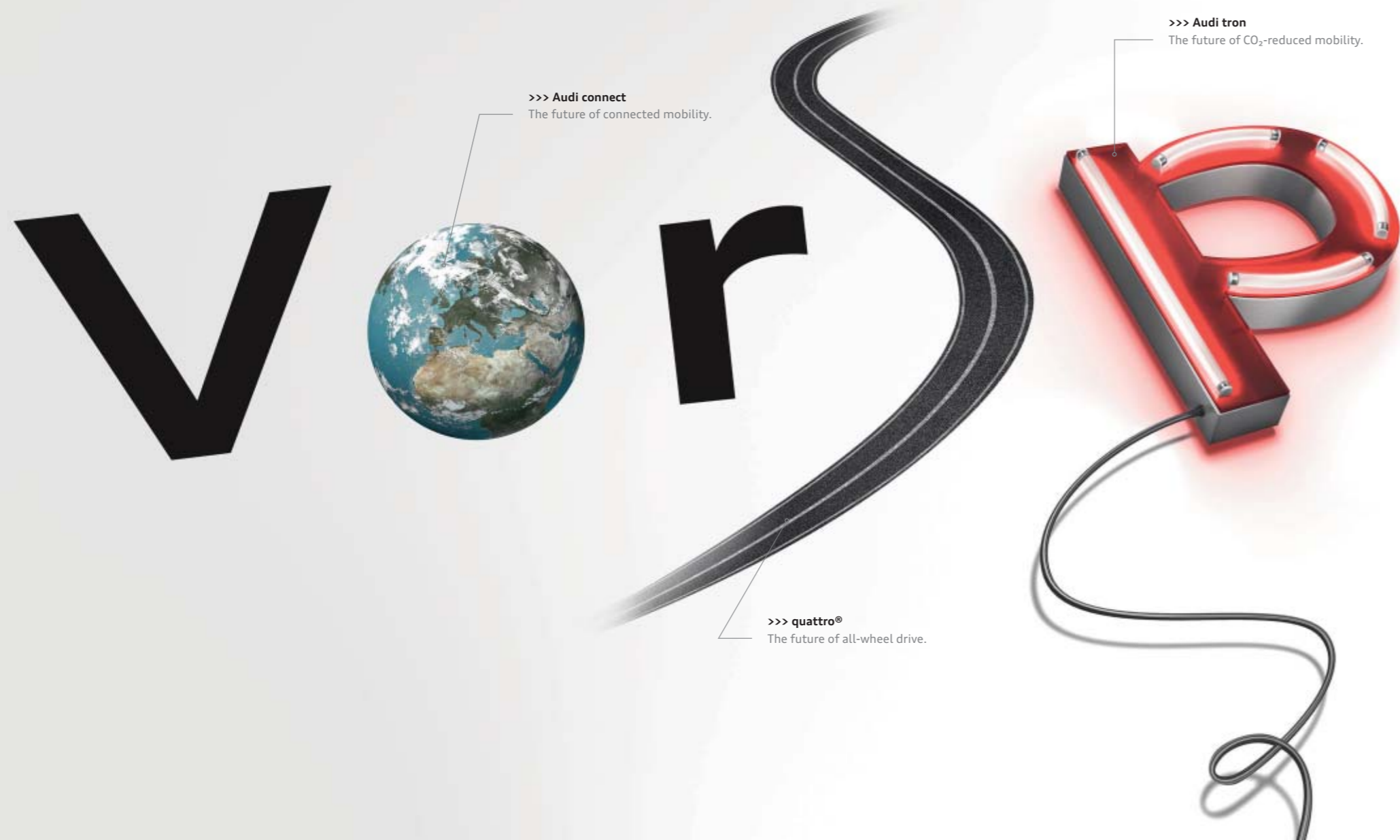

>>> Audi connect  
The future of connected mobility.

>>> Audi tron  
The future of CO<sub>2</sub>-reduced mobility.

>>> quattro®  
The future of all-wheel drive.



>>> Audi ultra  
The future of efficient technologies.

>>> Design  
Reshaping the future.

## ... durch Technik.

The world is constantly changing. Technology is advancing at an ever faster pace. And in the process, more and more opportunities are opening up to you – nowhere more so than in the field of mobility. We are playing an instrumental role in shaping this progress with Vorsprung durch Technik. Striving to provide you with technology that enriches your life. Making sure that we don't just satisfy your expectations of mobility both today and in the future, but continue to surpass them.

Audi ultra

# Perfectly combined.

## The future of efficient technologies.

Building an Audi is an extremely complicated business. And yet a simple principle applies for all models: all vehicle components interlock precisely in order to produce emission-reducing synergies. What started in accordance with this principle at the end of the 1980s with Audi lightweight construction and the revolutionary Audi Space Frame (ASF®) is now known as the reversal of the weight spiral: every lightweight component has an impact on other components, which can in turn be made smaller. In this way, existing forms and materials are continuously being improved with regard to their functionality, the lowest possible weight and their production process. With the goal of building vehicles that are even more efficient and make more sparing use of resources. At the same time, more and more efficiency technologies are being built into an Audi. These include recuperation and the start-stop system. Not to mention progressive, efficient high-tech engines. For greater driving dynamics, high compression, more efficient combustion and lower CO<sub>2</sub> emissions. All this is known as Audi ultra. Today and in the future – towards CO<sub>2</sub>-reduced mobility.

### >>> Aerodynamics

Less drag, more efficiency. Thanks to the consistently aerodynamic styling of the vehicle's lines, its underbody and spoiler edges – in order to achieve the best possible form for aerodynamic efficiency. Not forgetting tyres with reduced rolling resistance. All tested in the Audi wind tunnel at up to 300 km/h.

### >>> Lightweight expertise

Less weight. More savings, power and endurance. Audi lightweight technology. What started with lightweight body construction has now made its way into nearly all areas, combining innovative materials such as aluminium, carbon and magnesium, intelligent design principles and resource-saving manufacturing processes into an overall concept.

### >>> Recuperation

Braking that leads to even more efficient driving. With brake energy recovery (recuperation). Part of the kinetic energy produced when braking and coasting is temporarily stored in the vehicle's battery and then used when accelerating. Depending on the driving cycle, this can save up to 3% of fuel.

### >>> Transmission expertise

Improved efficiency thanks to improved transmission ratios. A higher torque output makes longer ratios possible, especially in higher gears. For powerful torque in the low engine speed range which reduces consumption – yet has no adverse effects on driving performance and sportiness.

### >>> Engine expertise

Powerfully and efficiently driven. By Audi ultra with efficiency technologies in the engine sector. Such as Audi cylinder on demand and the Audi valvelift system, which both reduce the amount of energy consumed by the engine, or clean diesel technology, which can help to reduce emissions.

## Mobility & navigation

**POI** **Point-of-interest (POI) search with voice control**  
in the Google™<sup>1</sup> database

**Traffic information online**  
Dynamic route guidance with real-time traffic flow information for individual stretches of road

**myAudi – special destinations<sup>2</sup>**  
The navigation system as a personal road atlas: import individual point-of-interest (POI) lists to the vehicle via the myAudi portal.

**Flight information**  
Get information conveniently from inside your vehicle about departure and arrival times as well as the corresponding gates and search directly for flight numbers if you want.

**Train information**  
Find departure and arrival times and the right platforms while you're on the road.

**Country information<sup>2</sup>**  
displays the legal regulations for a specific country such as whether it is compulsory to carry a high-visibility vest or purchase a motorway sticker as well as maximum speeds when the vehicle crosses a border

**Picturebook navigation**  
GPS data from your photos get you to your destination.

**Fuel prices**  
the cheapest petrol stations at your destination or in the vicinity

**P** **Parking information**  
Help with looking for car parks and multistoreys, plus – where available – information on prices and currently vacant spaces

**Navigation with Google Earth™<sup>1</sup> and Google Street View™<sup>1</sup>**  
uses high-resolution aerial and satellite images, photos and address information to guide you to your destination even more easily

<sup>1</sup> Google and the Google logo are registered trademarks of Google Inc. <sup>2</sup> Part of the optional MMI navigation plus with MMI touch.

<sup>3</sup> Provided the mobile phone has the Bluetooth profile MAP (Message Access Profile). Please contact your Audi partner or visit [www.audi.com/bluetooth](http://www.audi.com/bluetooth) for information on compatible mobile phones.

<sup>4</sup> Requires the optional MMI navigation plus with MMI touch including voice control system and Bluetooth interface and multifunction leather steering wheel. <sup>5</sup> For information on when this feature will be available, please contact your Audi partner. Depending on country-specific availability. You will generally require a media streaming service account to use this service which can lead to additional costs.

Availability, screen display and the cost of services vary depending on the country, model, device and tariff. For further legal information and notes on use, please see page 94 or visit [www.audi.com/connect](http://www.audi.com/connect).

**Map update online<sup>2</sup>**  
The map version delivered can be updated free of charge with the first 5 navigation updates that are released at intervals of 6 months. In conjunction with Audi connect, the update can be carried out online in the vehicle.

**Destination entry via myAudi or Google Maps™<sup>1</sup>**  
If you want, you can plan your navigation destinations conveniently from your PC or smartphone. myAudi and Google Maps™<sup>1</sup> or the Audi MMI connect app allow individual navigation destinations to be sent to the vehicle. When you start your journey, these can easily be loaded as your destination.

## Communication

**Wi-Fi hotspot**  
connects your mobile devices to the internet

**Email<sup>2</sup>**  
can be transmitted to your Audi MMI and conveniently read out

**Messages (SMS)<sup>3</sup>**  
Display or have text messages conveniently read out to you and immediately respond using the dictation function

**Access to Facebook**  
integrates your personal network into the cockpit. With text-to-speech and other convenient text functions

**Access to Twitter**  
integrates the Twitter message service into the cockpit. With text-to-speech and other convenient text functions

**Access to smartphone voice control<sup>4</sup>**  
e.g. Siri (iPhone 4s and higher). You can access smartphones connected by Bluetooth even whilst driving by pressing and holding the voice control key on the multifunction leather steering wheel. Controlled safely and conveniently via the microphones and loudspeakers in your Audi.

# Audi connect.

## Audi connect

## The future of connected mobility.

The world presents you with countless possibilities. The optional Audi connect enables you to make the most of many of them in digital form directly from your Audi. At the push of a button. Tailored to you. Thanks to myAudi and the services supported by Audi connect in your vehicle. In places all over the world. Intuitively, easily and conveniently.

### myAudi – your personal control centre

provides you with password-protected access to [www.audi.com/myaudi](http://www.audi.com/myaudi) where, following one-off registration, you are able to put together the services supported by Audi connect that you require, and manage and configure them from the comfort of your own home. You can also use many of these services via the Audi MMI connect app on your smartphone (Android 4.0 and higher or iOS 6 and higher) while you're on the road.

## Infotainment

**Weather**  
forecasts and maps for the required destination

**Online media streaming<sup>5</sup>**  
Access to personal radio services and global radio stations via smartphone app, as well as connection to music streaming services which provide access to millions of songs. In addition, you can access the music stored on your smartphone.

**News online (individual)**  
text and images about current world events, with text-to-speech function, can be configured individually

**City events**  
up-to-date information about events – e.g. at your destination

**Travel information**  
sightseeing information – with a function for importing the destination to the navigation system

Have the road completely under control, thanks to permanent distribution of the drive force to all four wheels. Variably controlled by the centre differential. Always depending on the situation. Experience handling stability, dynamism and agility as never before and combat the effects of over- and understeer with quattro with optional sport differential. For increased traction and superior propulsive power. Tame any road. And always keep your eyes set on where you're heading. In bends. On straights. Over any surface. For a fascinating experience that sticks. To the road – and in your mind.



*quattro®*  
**Stick to  
the road**

*With quattro®.*

Intelligent performance.

# Maximum power. Put to maximum use.

Every movement originates from something. Something that sets it off, an idea. The engine in your new Audi A6 can also be traced back to an initial spark of inspiration: higher power with lower fuel consumption. These apparently conflicting aims are united in two revolutionary drive technologies: TDI and TFSI. Get acquainted with both of them. And then opt for the drive system that you feel most moved by.



The fuel consumption and CO<sub>2</sub> emission figures can be found from page 104 onwards.

Intelligent performance.



## TDI®

With their combination of direct injection and turbocharging, Audi TDI engines promise exceptional performance – thanks to their high torque output over the entire engine speed range with constant power build-up. They are renowned for being fuel-efficient and for reducing emissions. But they are incredibly dynamic too – letting you get the maximum out of any road.



## TFSI®

Audi TFSI engines attain a particularly high compression rate. The result: outstanding efficiency combined with optimum performance. Substituting supercharging for cubic capacity has the effect of considerably reducing engine size and weight – while performance remains as impressively dynamic as ever. For power delivery that will win you over from the word go.

## Audi cylinder on demand

Even cylinder heads can be intelligent, as Audi cylinder on demand proves. Four of the TFSI engine's eight cylinders automatically shut down in the partial-load range. This helps to lower fuel consumption at the same time as reducing emissions. Without the switchover even being noticed or impairing the driving dynamics.



**>>> ESP with electronic axle-differential lock**

The ESP stabilisation system with electronic axle-differential lock selectively applies minimum brake pressure if there is insufficient load on the inside front wheel. This braking action diverts excessive torque to the outside wheel so that it can transmit more drive force to the road, thus improving traction.

**>>> adaptive air suspension**

The electronically controlled air suspension system acts individually at each of the 4 wheels and makes sure that the handling characteristics are barely affected, even when carrying heavy loads. Also available in the sport version for the S model with even stiffer damping.

**>>> Dynamic steering**

The dynamic steering enhances handling and driving comfort with speed-sensitive control of the steering ratio.

**>>> Audi drive select**

Audi drive select lets you adjust the driving characteristics of the Audi A6 to your requirements. At the push of a button. Sportier, more comfortable, more balanced, more economical or even individually tailored as you please. It's entirely up to you.

**>>> tiptronic**

The 8-speed automatic transmission with Dynamic Shift Program (DSP) ensures faster gear changes without any perceptible break in propulsive power.

**>>> S tronic®**

The sporty, efficient dual-clutch transmission allows you to switch gears with lightning speed without a noticeable break in propulsive power.

**>>> quattro®**

The permanent all-wheel drive system distributes the drive forces to each individual wheel according to the driving situation for extra traction and dynamic performance.

**>>> quattro® with sport differential**

The quattro permanent all-wheel drive with electronically controlled sport differential guarantees superb agility and thrilling driving dynamics.

**>>> Ceramic brake**

The ceramic brakes fitted at the front and rear axles ensure excellent braking performance in any driving situation.

Dynamics

# Dynamics

## that will take hold of you.

Get in. Buckle up. Start the engine. Wherever you're heading, enthralling driving dynamics will power you there. For as you know, the world is your oyster once you get behind the wheel of your Audi A6. You decide the direction. The driving style. The pace. And you enjoy the satisfaction of knowing you have plenty in reserve. More than enough to get the very best from every drive.

The fuel consumption and CO<sub>2</sub> emission figures can be found from page 104 onwards.

You can find out which equipment features are available as standard or optional in your model by referring to the index starting on page 114.



**>>> Audi pre sense basic**

initiates preventive occupant protection measures in the event of an impending accident

**>>> Camera-based speed limit display**

recognises speed limits and notifies you of them via the driver information system and head-up display

**>>> Audi active lane assist**

helps you to keep in lane by means of gentle steering intervention when lane boundary markings are detected

**>>> adaptive cruise control including Audi pre sense front**

monitors the traffic ahead and automatically maintains a constant distance wherever possible

**>>> Audi side assist including Audi pre sense rear**

helps you when changing lanes and initiates preventive protection measures when an impending rear-end collision is detected

**>>> Audi Matrix LED headlights**

track the road ahead and illuminate it according to the situation with their innovative LED layout for even greater safety

**>>> Night vision assistant**

improves convenience at night thanks to its integrated thermal imaging camera, highlighting any pedestrians and larger wild animals detected

**>>> Head-up display**

projects key information onto the windscreen at eye level so there is no need to take your eyes off the road

**>>> Parking system plus with 360 degree cameras**

provides a better overview for parking and manoeuvring by offering a choice of different camera angles all around the vehicle

**>>> Park assist with display of surroundings**

supports comfortable parking and leaving a parking space by temporarily performing steering actions

**Assistance systems**

# Wherever you're heading, peace of mind will be your constant companion.

**With the assistance systems in your new Audi A6.**

Each drive is different. Yet they all have one thing in common – the feeling of being protected that you get from every Audi. All driver assistance systems in your new Audi A6 help you during your journey and guarantee even greater comfort when you're on the road. Get to know the most important driver assistance systems.

**>>> Audi connect**

Use all the optional services supported by Audi connect with MMI navigation plus with MMI touch – quickly and easily. The intuitive operation of the MMI makes accessing the internet-based functions remarkably straightforward.

**>>> Navigation**

With MMI navigation plus with MMI touch you can let yourself be guided to your destinations with even greater ease via the 3D map view and 3-dimensional display of places of interest and landmark buildings.

**>>> Car**

Control and alter driver assistance systems, vehicle settings as well as climate control and service functions quickly and easily from MMI radio upwards.

**>>> Media**

Display the covers of your music collection on all available media sources such as jukebox, inserted SD cards, Audi music interface, CDs or DVDs.

**>>> MMI® touch**

MMI touch makes operating the individual components of the Multi Media Interface even easier. The touchpad can even be operated using just one finger.

**Simplicity****The MMI® – intelligent, individual, intuitive.**

Streamlined. Simple. Logical. The world of mobile infotainment completely redefined: the Multi Media Interface (MMI). Phoning, navigating or surfing the internet via Audi connect: all highly intuitive, highly functional and highly convenient – not least thanks to voice control. With the MMI in your new Audi A6, everything will be child's play for you.



Audi Matrix LED headlights

*See well.*

Darkness is relative. The optional Audi Matrix LED headlights turn night into day. The all-new headlight technology produces a light colour similar to that of daylight. Bends are anticipated to illuminate them more clearly. Vehicles are detected and the light distribution of your Audi A6 adapts according to the situation. This is all made possible by an array of sensors and a camera. As well as dimmable LEDs in an innovative arrangement – which, incidentally, are quite a sight in their own right.



Audi Matrix LED headlights won't thrill you only at night. The new lighting technology is quite a spectacle during the day, too, sometimes appearing as light points, sometimes as a dynamic light strip. Individually controllable LEDs. Perfectly adapted to the situation in hand. Showing the way ahead. An impressive sight, time and time again.

The fuel consumption and CO<sub>2</sub> emission figures can be found from page 104 onwards.

*Look good.*



**As unique as you are.**  
The equipment options.

Sportiness, comfort, design, functionality – whatever you demand of your Audi, it offers you a wealth of custom options. Audi equipment versions are varied and high-quality and you can tailor them entirely to your needs.

## Character takes on many forms. Here are four of them.

What makes an Audi your Audi? Vehicle equipment entirely tailored to your needs. There are a wide range of options available to you for giving your vehicle the exact touch you have in mind. More sportiness? More elegance? Let yourself be inspired.

### Audi A6 Saloon in mythos black, metallic

Audi Matrix LED headlights

Audi Sport cast aluminium wheels in 10-spoke design  
in matt titanium look, gloss turned finish\*

Dark-tinted windows (privacy glazing)

Customised contour seats, front in Valcona leather,  
Atlas beige perforated with memory function and seat  
ventilation

Inlays in Beaufort walnut



### Audi S6 Saloon in Misano red, pearl effect

Audi exclusive black gloss package

Cast aluminium wheels  
in 5-parallel-spoke star design (S design)

Sport exhaust system with high-gloss black trims

Exterior mirror housings in body colour

S sport seats, front in Valcona leather, lunar silver with  
contrasting stitching and S embossing in backrests

Inlays in carbon Atlas



**Audi A6 allroad quattro  
in tornado grey, metallic**

Full paint finish including aluminium-look exterior

Audi Sport cast aluminium wheels in 5-twin-spoke design in matt titanium look, gloss turned finish\*

Audi design selection flint grey

Multifunction sport leather steering wheel in 3-spoke design with shift paddles and allroad emblem

Inlays in fine grain ash, natural brass



**Audi A6 Avant  
in floret silver, metallic**

LED rear lights with dynamic indicator

Audi Sport cast aluminium wheels in 10-Y-spoke design

Dark-tinted windows (privacy glazing)

Sport seats, front in Valcona leather, nougat brown

Multifunction sport leather steering wheel in 3-spoke design with shift paddles

Inlays in aluminium delta, silver



## Sportiness that can be seen and felt. Even when stationary.

S stands for sportiness. The new Audi S6 Saloon and the new S6 Avant are impressive proof of this. With extensive S-specific equipment. For a dynamic look. Sporty comfort. And superior performance. And you also have the option of further enhancing the S-factor. With optional equipment that is equally impressive to the senses.



The fuel consumption and CO<sub>2</sub> emission figures can be found on page 108.

### S6-specific standard equipment

**Cast aluminium wheels in 5-parallel-spoke design (S design)**  
size 8.5 J x 19 with 255/40 R 19 tyres\*

**Brake callipers, painted black**  
with S6 logo at the front

**Audi Singleframe**  
radiator grille in platinum grey with horizontal double chrome struts and S6 emblem

**Front bumper**  
in a striking sporty design with air inlet grilles in honeycomb design and double chrome struts; including aluminium-look blade

**Exterior mirror housings**  
in aluminium look

**Side sill trims**

**Diffuser insert, rear**  
in platinum grey, edged with a blade in aluminium look

**Exhaust tailpipes**  
dual-branch design with 2 oval chrome surrounds on both left and right

**Rear spoiler (S6 Saloon)**  
integrated in the luggage compartment lid

**Roof edge spoiler (S6 Avant)**

### Model name/logo

- S6 emblem in the Audi Singleframe, on the luggage compartment lid and on the vehicle key
- V8 T logo on the front wings

also available without model name/logo on the rear on request

**Door sill trims with aluminium inlays**  
with S6 logo

**Pedals and footrest in stainless steel**

**Instrument cluster**  
with grey dials, white needles and S6 logo in the rev counter; dynamic ready-check

**Driver information system with colour display**

**Multifunction sport leather steering wheel in 3-spoke with shift paddles in aluminium look**  
with S6 emblem and S-specific contrasting stitching

**Selector lever knob in aluminium look**  
with S6 emblem

**Engine start-stop button**  
with red ring

**Sport seats, front**

**Seat upholstery in Alcantara/leather, black or lunar silver**  
with S6 embossing on the front-seat backrests

**Front seats, electrically adjustable**  
including memory function for the driver seat

**4-way lumbar support for the front seats**

**Centre armrest, front**

### Inlays

Matt brushed aluminium

**Velour floor mats, front and rear**

**4-zone deluxe automatic air conditioning**

**LED headlights**

**LED rear lights with dynamic indicator**

**MMI® radio plus**

**Audi music interface**

**Bluetooth interface**

**Audi sound system**

**Storage package**

**Through-loading facility**

**Anti-theft alarm**

**quattro® permanent all-wheel drive**

**adaptive air suspension – sport**  
with S6-specific tuning

**Audi cylinder on demand**

**Active Noise Cancellation**  
The Active Noise Cancellation system can compensate for noises from individual frequencies depending on the engine speed.

### S6-specific optional equipment (extract)

**Paint finish in the special colour Sepang blue, pearl effect**

**Cast aluminium wheels in 5-parallel-spoke star design (S design)**  
size 8.5 J x 20 with 255/35 R 20 tyres\*

**Cast aluminium winter wheels in 5-parallel-spoke star design (S design)**  
size 8.5 J x 20 with 255/35 R 20 tyres\*, cannot be fitted with snow chains, top-speed suitable

**Sport exhaust system**  
for an increased sound experience; dual-branch design, 2 oval tailpipes each left and right with high-gloss black trims

**S sport seats, front**

**Seat upholstery**  
with S sport seats in Valcona leather, black or lunar silver, each with contrasting stitching and S6 embossing in the front-seat backrests; for customised contour seats in Valcona leather, black or flint grey without S6 embossing in the backrests

**Inlays**  
carbon Atlas

**Audi design selection Arras red**  
with inlays in carbon twill, red

**quattro® with sport differential**  
with S6-specific tuning

**Dynamic steering**  
with S6-specific tuning

\*You will find specifications on the technical characteristics of tyres on page 113.

## There's a sign for maximum efficiency at Audi. The Audi A6 ultra models – the most sustainable TDI® and TFSI® models in the range.

Technologies and measures for reducing consumption and emissions without any reduction in driving enjoyment – that's what Audi ultra stands for. Standard in every Audi model. The long-term aim: completely emission-free mobility. To achieve this, we are systematically continuing our development work. On more and more efficient drive technologies, for example. Such as the economical diesel engines. We award the most sustainable of these with the ultra emblem on the rear of the model, which announces: maximum efficiency ahead. Thanks to combined CO<sub>2</sub> emission values from 110 g/km for the Audi A6 2.0 TDI ultra models and from 133 g/km for the 1.8 TFSI model. And without having to give up the dynamics typical of Audi. Experience the Audi A6 ultra models – vehicles that redefine efficient driving.

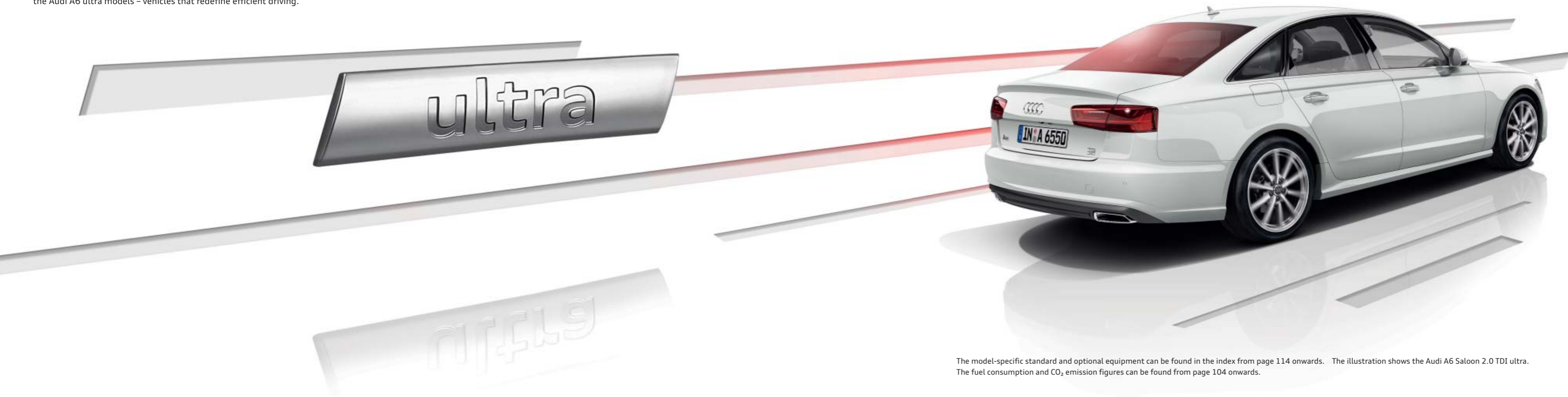

The **2.0 litre TDI ultra engine** with 110 kW has the following CO<sub>2</sub> emission values in the combined driving cycle:  
A6 Saloon: from 110 g/km (S tronic) or from 114 g/km (manual transmission)  
A6 Avant: from 115 g/km (S tronic) or from 118 g/km (manual transmission)

The **2.0 litre TDI ultra engine** with 140 kW has the following CO<sub>2</sub> emission values in the combined driving cycle:  
A6 Saloon: from 110 g/km (S tronic) or from 114 g/km (manual transmission)  
A6 Avant: from 115 g/km (S tronic) or from 119 g/km (manual transmission)

The **1.8 litre TFSI ultra engine** with 140 kW has the following CO<sub>2</sub> emission values in the combined driving cycle:  
A6 Saloon: from 133 g/km  
A6 Avant: from 137 g/km

The A6 2.0 TDI ultra models and the A6 1.8 TFSI ultra model are available with all equipment without any restrictions.

The model-specific standard and optional equipment can be found in the index from page 114 onwards. The illustration shows the Audi A6 Saloon 2.0 TDI ultra. The fuel consumption and CO<sub>2</sub> emission figures can be found from page 104 onwards.



## The right driving force for every personality.

No matter which Audi engine you choose, they all have high compression ratios, highly efficient combustion and outstanding efficiency. In short, they deliver more power whilst using less fuel and producing fewer emissions.



3.0 TDI

**TDI®**

Audi TDI engines: high torque output over the entire engine speed range – with constant power build-up. They are renowned for being fuel-efficient and for reducing emissions. The 3.0 TDI quattro, for example: 235 kW. In the Audi A6 Saloon with a top speed of 250 km/h and an acceleration from 0 to 100 km/h in 5.0 seconds. All TDI engines comply with the EU6 emission standard.

- A6 2.0 TDI ultra (110 kW)
- A6 2.0 TDI ultra (140 kW)
- A6 3.0 TDI clean diesel (160 kW)
- A6 3.0 TDI clean diesel quattro (160 kW)\*
- A6 3.0 TDI clean diesel quattro (200 kW)\*
- A6 3.0 TDI clean diesel quattro (235 kW)\*



4.0 TFSI with Audi cylinder on demand technology

**TFSI®**

The Audi TFSI engines offer outstanding efficiency and improved performance whilst at the same time retaining their dynamism. The 1.8 TFSI (140 kW) in the Audi A6, for example. Or the 4.0 TFSI quattro with 331 kW in the Audi S6 – from 0 to 100 km/h in 4.4 seconds. All TFSI engines comply with the EU6 emission standard.

- A6 1.8 TFSI (140 kW)
- A6 1.8 TFSI ultra (140 kW)
- A6 2.0 TFSI (185 kW)
- A6 3.0 TFSI quattro (245 kW)\*
- S6 4.0 TFSI quattro (331 kW)

\*Also available in the A6 allroad quattro. The fuel consumption and CO<sub>2</sub> emission figures can be found from page 104 onwards.

## Remaining faithful to the sporty line: the S line packages.

The S line packages emphasise the sporty character of your Audi A6. Accentuate the dynamic body line, lend the interior even more expression or give the suspension even sportier definition for enhanced driving dynamics. And make a true athlete of your Audi.



The fuel consumption and CO<sub>2</sub> emission figures can be found from page 104 onwards.

### S line exterior package

**Front and rear bumpers, side radiator grilles, side sill trims and diffuser insert**  
in a striking, sporty design

**Diffuser insert**  
painted in platinum grey

### S line roof edge spoiler (A6 Avant)

**Door sill trims**  
with S line logo; door sill trims illuminated in conjunction with ambient lighting and without S line logo

**S line emblem**  
on the front wings

**Paint finish in all standard/optional equipment colours** and additionally in the special colours Daytona grey, pearl effect and Misano red, pearl effect



### S line sport package

**The S line sport package includes the following equipment items:**

**Audi Sport cast aluminium wheels in 5-twin-spoke design**  
size 8 J x 18 with 245/45 R 18 tyres\* (for 4-cylinder only) or size 8.5 J x 19 with 255/40 R 19 tyres\*. From quattro GmbH

**S line sport suspension**  
with more dynamic suspension tuning and vehicle lowered by 30 mm compared to dynamic suspension

**Door sill trims**  
with S line logo; door sill trims illuminated in conjunction with ambient lighting and without S line logo

**S line emblem**  
on the front wings

**Interior, dashboard and headlining**  
in black, with contrasting stitching on sport leather steering wheel and gear/selector lever gaiter; in sequence cloth/leather and perforated Alcantara/leather additionally with contrasting stitching on seat upholstery, armrests in the door trim inserts and centre armrest, front (if ordered); lower part of centre console in leather

**Floor mats, front**  
in black, in conjunction with Alcantara/leather or Valcona leather, lunar silver with piping in contrasting colour

**Sport seats, front**  
including electric lumbar support

**S line seat upholstery in sequence cloth/leather, black** with S line embossing on the front-seat backrests

**S line multifunction sport leather steering wheel in 3-spoke design**  
in black leather (steering wheel grips in perforated leather) and with S line emblem

**Gear/selector lever knob**  
in perforated black leather

**S line inlays**  
in matt brushed aluminium

**Pedals and footrest in stainless steel**

### Optionally available:

**Further 18-inch or larger wheels**

**adaptive air suspension**

**S sport seats, front**

**S line seat upholstery in perforated Alcantara/leather, black or Valcona leather, black or lunar silver** with S line embossing on the front-seat backrests

**S line multifunction sport leather steering wheel in 3-spoke design with shift paddles**  
optionally heated; in black leather (steering wheel grips in perforated leather) and with S line emblem

**S line inlays**  
in piano finish, black, fine grain ash, natural brown, Beaufort walnut or aluminium/Beaufort, black

**Paint finish in all standard colours/optional equipment colours and additionally in the special colour of Daytona grey, pearl effect**

\*You will find specifications on the technical characteristics of tyres on page 113.

## As unmistakable as your own standards: the Audi design selection.

The Audi design selection offers you an aesthetic pre-selection of special materials and colours for the interior. The fine leather upholstery and trim in the colours flint grey or Arras red with attractive contrasting stitching give the interior an exclusive ambience.



### Audi design selection flint grey (A6)

The Audi design selection flint grey includes the following equipment items:

- Customised contour seats, front, optionally with seat ventilation
- Seat centre panel of front seats and the two outer rear seats in perforated Valcona leather, flint grey with contrasting stitching in brass
- Seat side bolsters, centre rear seat, head restraints, door trim inserts and centre armrest, front (if ordered) in Valcona leather, flint grey with contrasting stitching in brass
- Door armrests and lower part of centre console in leather, flint grey with contrasting stitching in brass
- Inlay in fine grain ash, natural brass
- Upper part of dashboard in granite grey, lower part in flint grey
- Steering wheel in granite grey
- Floor mats in velour, flint grey with contrasting stitching in brass



### Audi design selection Arras red (S6)

The Audi design selection Arras red includes the following equipment items:

- S sport seats, front with S6 embossing in the backrests
- Seat centre panels with diamond pattern, seat side bolsters, head restraints, door trim inserts, door armrests and centre armrest, front in Valcona leather, Arras red with contrasting stitching in granite grey
- Door trim and lower part of centre console in Alcantara, black
- Inlays in carbon twill, red
- Floor mats in velour, black
- Dashboard and steering wheel in black



The fuel consumption and CO<sub>2</sub> emission figures can be found from page 104 onwards.

## Your personality. Your Audi. The Audi exclusive line.

Every Audi – custom-built for you. With the Audi exclusive line we are offering you the chance to tailor your car. Selected décors and materials are combined into a harmonious whole on the interior. So you can emphasise your own particular style with elegance.



Audi exclusive line is from quattro GmbH.

### Audi exclusive line

**Customised contour seats, front**  
including memory function; optionally with seat ventilation, front

**Seat upholstery**  
Seat side bolsters and head restraints in Valcona leather, alabaster white with contrasting stitching in powder beige; seat centre panels in perforated leather (with Audi exclusive line-specific perforation) in alabaster white with accordion pleat in powder beige; backrest covers and seat attachments in matching colour in alabaster white

**Black interior**  
Headlining in cloth, black

**Centre armrest, front**  
in leather, alabaster white with contrasting stitching in powder beige

**Door trims**  
Door trim inserts in leather, alabaster white; leather-covered armrests in the doors in alabaster white with contrasting stitching in powder beige

**Inlays**  
Eucalyptus, natural

**Floor mats**  
in black with piping and contrasting stitching in alabaster white

**Door sill trims**  
with Audi exclusive line logo; door sill trims illuminated in combination with ambient lighting



## You have an exclusive character. So why shouldn't your Audi have one too?

That the Audi exclusive range aspires to exclusivity is already evident from its name. Selected décors and coloured leather can be combined with customised paint finishes from the large selection of Audi exclusive colours to suit your own personal preferences. So you can highlight your car's exceptional character to even better advantage. Your Audi partner and the Audi exclusive Studio of the Audi Forum Neckarsulm await your wishes.



Audi exclusive line Audi exclusive Audi exclusive

**Audi A6 Saloon with Audi exclusive customised paint finish in Suzuka grey, metallic and Audi exclusive black gloss package**

Audi Sport cast aluminium 5-twin-spoke design in matt titanium look, gloss turned finish\*

Audi exclusive leather upholstery and trim (package 1) in Valcona leather in black with contrasting stitching and accordion pleat in crimson red

Audi exclusive extended leather package in black with contrasting stitching in crimson red

Audi exclusive leather controls in black with contrasting stitching in crimson red

Audi exclusive seat belts in crimson red

Inlays in aluminium/Beaufort, black



## Your Audi is painted not just once. But four times.

When you choose a paint colour, choose one that best reflects your own personality. But whichever colour you opt for, you can count on the outstanding quality of our painting process. Though no thicker than a human hair, the layer of paint on an Audi is actually made up of four different coats. So not only do you look radiant in your Audi, the car is also optimally protected from environmental influences and wear. For its entire lifetime.



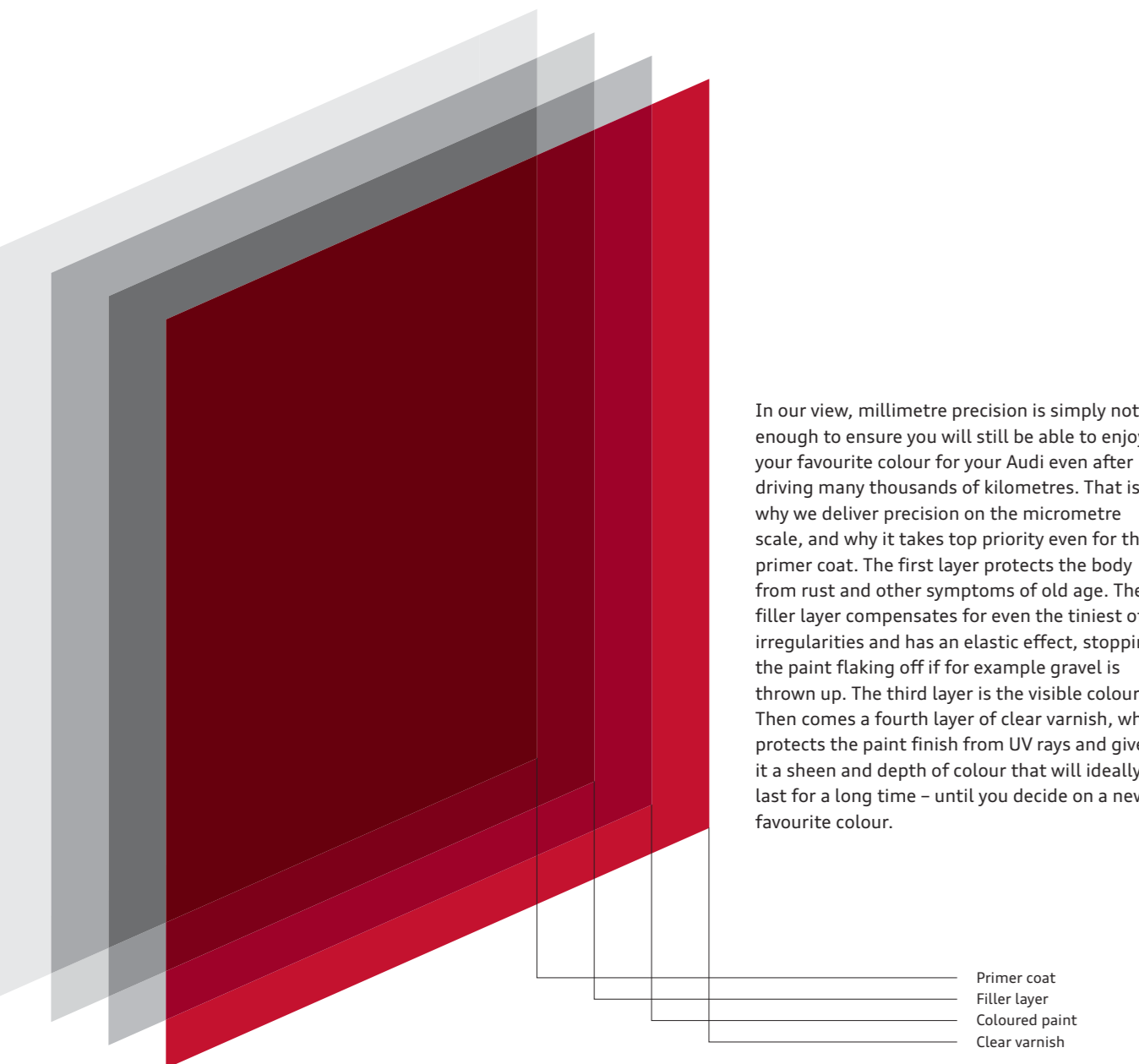

In our view, millimetre precision is simply not enough to ensure you will still be able to enjoy your favourite colour for your Audi even after driving many thousands of kilometres. That is why we deliver precision on the micrometre scale, and why it takes top priority even for the primer coat. The first layer protects the body from rust and other symptoms of old age. The filler layer compensates for even the tiniest of irregularities and has an elastic effect, stopping the paint flaking off if for example gravel is thrown up. The third layer is the visible colour. Then comes a fourth layer of clear varnish, which protects the paint finish from UV rays and gives it a sheen and depth of colour that will ideally last for a long time – until you decide on a new favourite colour.

- Primer coat
- Filler layer
- Coloured paint
- Clear varnish

**| Solid paint finishes**



Ibis white

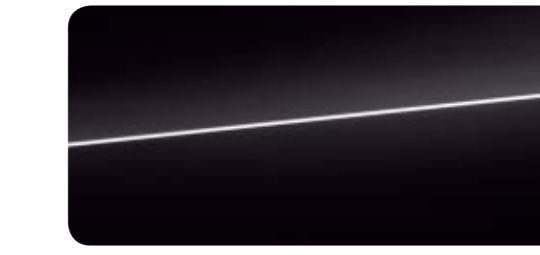

Brilliant black

**| Metallic paint finishes**



Glacier white, metallic

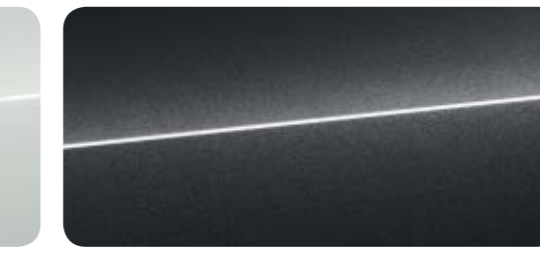

Oolong grey, metallic

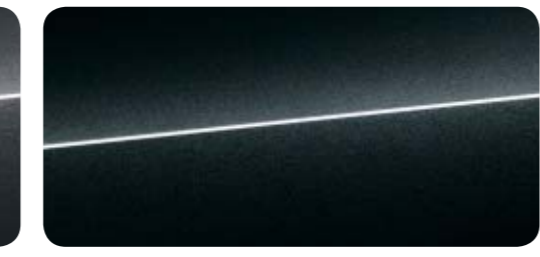

Mythos black, metallic

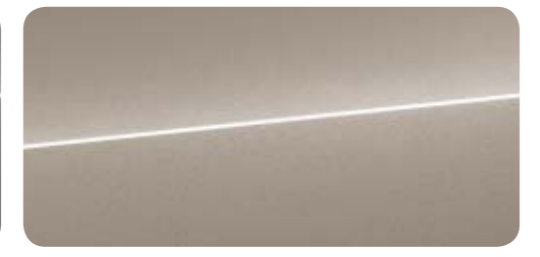

Carat beige, metallic



Floret silver, metallic

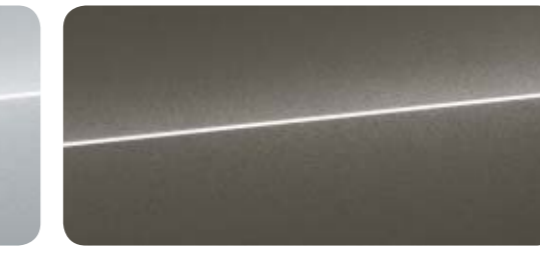

Dakota grey, metallic

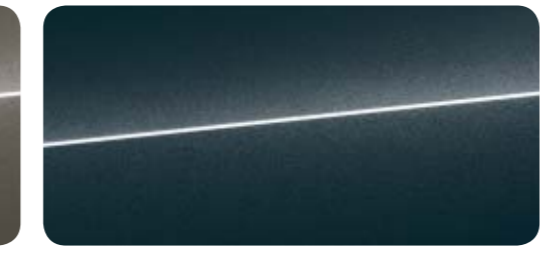

Aviator blue, metallic

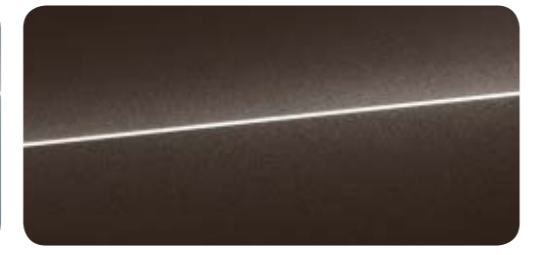

Java brown, metallic  
only available for A6 allroad quattro



Tornado grey, metallic

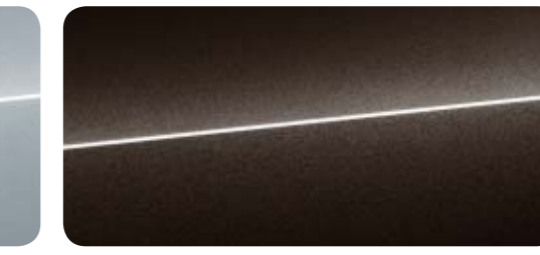

Havana black, metallic

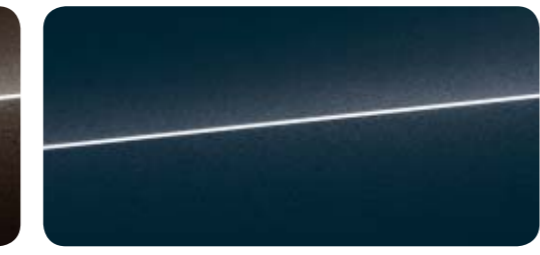

Moonlight blue, metallic

**| Pearl effect paint finishes**



Misano red, pearl effect  
for A6 Saloon and A6 Avant only in conjunction with S line exterior package

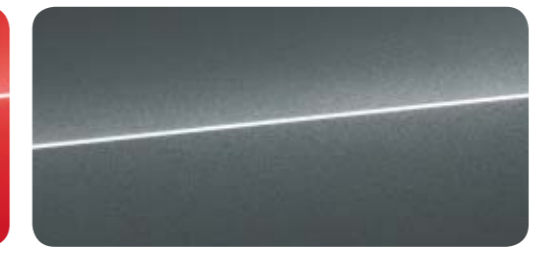

Daytona grey, pearl effect  
for A6 Saloon and A6 Avant only in conjunction with S line exterior package or S line sport package

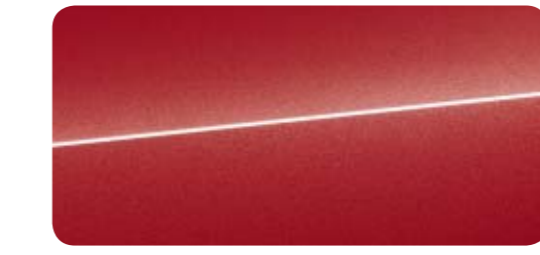

Garnet red, pearl effect



Sepang blue, pearl effect  
only available for S6 Saloon and S6 Avant

**| Individual paint finishes**



Audi exclusive customised paint finishes  
From quattro GmbH

**Exterior**  
Paint finishes Wheels/tyres

**| Contrasting/full paint finishes**

**Contrasting paint finish**  
Sills, bumpers, extended wheel arches and sill extensions painted in contrasting colour anthracite matt or black matt.

In conjunction with Audi exclusive customised paint finish: contrasting paint finish in black matt

**Matt anthracite**  
can be combined with the following paint finishes: ibis white, brilliant black, glacier white, metallic, Oolong grey, metallic, Havana black, metallic, mythos black, metallic, moonlight blue, metallic, Java brown, metallic

**Black matt**  
can be combined with the following paint finishes: floret silver, metallic, tornado grey, metallic, Dakota grey, metallic, carat beige, metallic, garnet red, pearl effect and all Audi exclusive paint finishes

**Full paint finish**  
Sills, bumpers and extended wheel arches painted in body colour with matt finish, including aluminium-look exterior (roof rails with double-bar design, roof frame and window slot trims in anodised aluminium, door handles and rear feature trim strips in aluminium look, sill extension with stainless steel insert).

Can be combined with the following paint finishes: glacier white, metallic, floret silver, metallic, tornado grey, metallic, Oolong grey, metallic, Dakota grey, metallic, Havana black, metallic, mythos black, metallic, moonlight blue, metallic, Java brown, metallic and with all Audi exclusive paint finishes

In conjunction with Audi exclusive customised paint finishes: sills, bumpers and extended wheel arches in body colour



**Quality given form.  
And a brilliant finish.  
Audi wheels.**

To make sure you have peace of mind for every metre of your drive, Audi puts its wheels through an exacting series of specialised test procedures. Hardness tests, for example, aim for maximum stability, while a copper accelerated salt spray test – CASS for short – using acetic acid guarantees the greatest possible corrosion protection. Thanks to these and many other measures, we can ensure that every Audi wheel offers maximum quality – even after scores of kilometres. No matter which of the numerous designs you choose.

| Summer wheels



Cast aluminium wheels in 7-arm design  
size 7.5 J x 16 with 225/60 R 16 tyres<sup>1</sup>



Cast aluminium wheels in 5-arm design  
size 8 J x 18 with 235/55 R 18 tyres<sup>1</sup>.  
Only available for A6 allroad quattro



Audi Sport cast aluminium wheels  
in 5-twin-spoke design<sup>2</sup>  
size 8 J x 18 with 245/45 R 18 tyres<sup>1</sup>



Forged aluminium wheels in 6-arm design  
size 8 J x 17 with 225/55 R 17 tyres<sup>1</sup>



Cast aluminium wheels in 10-spoke-V design  
size 8 J x 18 with 245/45 R 18 tyres<sup>1</sup>



Audi Sport cast aluminium wheels  
in 7-twin-spoke design<sup>2</sup>  
size 8 J x 18 with 245/45 R 18 tyres<sup>1</sup>



Cast aluminium wheels in 10-spoke design  
size 8 J x 17 with 225/55 R 17 tyres<sup>1</sup>,  
optionally with all-season tyres



Cast aluminium wheels in 5-V-spoke design  
size 8 J x 18 with 245/45 R 18 tyres<sup>1</sup>



Cast aluminium wheels in 10-spoke design  
size 8.5 J x 19 with 255/45 R 19 tyres<sup>1</sup>.  
Only available for A6 allroad quattro



Cast aluminium wheels in 15-spoke star design  
size 8.5 J x 19 with 255/40 R 19 tyres<sup>1</sup>,  
optionally available with run-flat tyres



Audi Sport cast aluminium wheels  
in 10-spoke design<sup>2</sup>  
size 8.5 J x 19 with 255/40 R 19 tyres<sup>1</sup>  
(on A6 allroad quattro with 255/45 R 19 tyres<sup>1</sup>)



Forged aluminium wheels  
in 5-arm star design, contrasting grey, partly polished<sup>3</sup>  
size 8.5 J x 20 with 255/35 R 20 tyres<sup>1</sup>



Audi Sport cast aluminium wheels  
in 5-arm rotor design in matt titanium look,  
gloss turned finish<sup>2,3</sup>  
size 8.5 J x 20 with 255/35 R 20 tyres<sup>1</sup>



Cast aluminium wheels  
in 5-parallel-spoke design (S design)  
size 8.5 J x 19 with 255/40 R 19 tyres<sup>1</sup>.  
Only available for S6 Saloon and S6 Avant



Cast aluminium wheels Audi Sport  
in 10-spoke design in matt titanium look,  
gloss turned finish<sup>2,3</sup>  
size 8.5 J x 19 with 255/40 R 19 tyres<sup>1</sup>  
(on A6 allroad quattro with 255/45 R 19 tyres<sup>1</sup>)



Cast aluminium wheels in 5-parallel-spoke design  
size 8.5 J x 20 with 255/40 R 20 tyres<sup>1</sup>.  
Only available for A6 allroad quattro



Audi Sport cast aluminium wheels  
in 5-twin-spoke design<sup>2</sup>  
size 8.5 J x 20 with 255/35 R 20 tyres<sup>1</sup>  
(on A6 allroad quattro with 255/40 R 20 tyres<sup>1</sup>)



Audi Sport cast aluminium wheels  
in 10-Y-spoke design<sup>2</sup>  
size 8.5 J x 19 with 255/40 R 19 tyres<sup>1</sup>  
(on A6 allroad quattro with 255/45 R 19 tyres<sup>1</sup>)



Audi Sport cast aluminium wheels  
in 5-twin-spoke design<sup>2</sup>  
size 8.5 J x 19 with 255/40 R 19 tyres<sup>1</sup>



Cast aluminium wheels  
in 5-parallel-spoke star design (S design)  
size 8.5 J x 20 with 255/35 R 20 tyres<sup>1</sup>.  
Only available for S6 Saloon and S6 Avant



Audi Sport cast aluminium wheels  
in 5-twin-spoke design in matt titanium look,  
gloss turned finish<sup>2,3</sup>  
size 8.5 J x 20 with 255/35 R 20 tyres<sup>1</sup>  
(on A6 allroad quattro with 255/40 R 20 tyres<sup>1</sup>)

The model-specific standard and optional equipment can be found in the index from page 114 onwards.

| Winter wheels



Cast aluminium winter wheels in 7-arm design  
size 7.5 J x 16 with 225/60 R 16 tyres<sup>1</sup>,  
can be fitted with snow chains, permissible top speed  
210 km/h



Cast aluminium winter wheels in 5-arm design  
size 7 J x 18 with 235/55 R 18 tyres<sup>1</sup>,  
can be fitted with snow chains, permissible top speed  
210 km/h. Only available for A6 allroad quattro



Cast aluminium winter wheels  
in 15-spoke star design  
size 7.5 J x 19 with 235/45 R 19 tyres<sup>1</sup>,  
can be fitted with snow chains, permissible top speed  
240 km/h



Cast aluminium winter wheels  
in 5-parallel-spoke star design (S design)  
size 8.5 J x 20 with 255/35 R 20 tyres<sup>1</sup>,  
cannot be fitted with snow chains, top-speed suitable.  
Only available for S6 Saloon and S6 Avant



Cast aluminium winter wheels in 6-arm design  
size 7.5 J x 17 with 225/55 R 17 tyres<sup>1</sup>,  
can be fitted with snow chains, permissible top speed  
210 km/h



Cast aluminium winter wheels in 5-arm design  
size 7.5 J x 18 with 225/50 R 18 tyres<sup>1</sup>,  
optionally available with run-flat tyres,  
can be fitted with snow chains, permissible top speed  
210 km/h



Cast aluminium winter wheels  
in 5-parallel-spoke design  
size 8.5 J x 20 with 255/40 R 20 tyres<sup>1</sup>,  
cannot be fitted with snow chains, permissible top  
speed 240 km/h. Only available for A6 allroad quattro

<sup>1</sup>You will find specifications on the technical characteristics of tyres on page 113. <sup>2</sup>From quattro GmbH. <sup>3</sup>Please note the special information relating to wheels on page 109.

## Premium quality you can rely on.

You have a special place in your Audi. Exclusive comfort can be felt on the front and rear seats: thanks to high-quality materials and first-class workmanship. No matter which seat upholstery you decide on and whether you prefer customised contour seats or sport seats or S sport seats with stable lateral support for dynamic driving: you're sitting in the right place.



**Customised contour seats, front** 1

including memory function for driver and front-passenger seat, and exterior mirrors. The illustration shows customised contour seat, front in Valcona leather, flint grey with seat ventilation.

The model-specific standard and optional equipment can be found in the index from page 114 onwards.



**Standard seats, front without seat ventilation** 2

The illustration shows standard seat, front in Milano leather, flint grey without seat ventilation.



**Standard seats, front with seat ventilation** 3

The illustration shows standard seat, front in Milano leather, flint grey with seat ventilation.



**Sport seats, front** 4

The illustration shows sport seats, front, in Valcona leather, black.

The model-specific standard and optional equipment can be found in the index from page 114 onwards.

**S sport seats, front** 5

including memory function for driver seat, and exterior mirrors.  
The illustration shows S sport seat, front, in Valcona leather, black, with contrasting stitching.

**| Cloth and leather upholstery and trim****Effect cloth upholstery and trim**

for standard seats, front: seat centre panels in effect cloth and seat side bolsters, head restraints, door trim inserts and centre armrest, front (if ordered) in single-colour cloth

**Contour cloth upholstery and trim**

for sport seats, front: seat centre panels in contour cloth and seat side bolsters, head restraints, door trim inserts and centre armrest, front (if ordered) in single-colour cloth

**Sierra/mono.pur 350 cloth upholstery and trim**

for standard seats, front: seat centre panels in Sierra cloth, black-brown, and seat side bolsters, head restraints and door trim inserts in mono.pur 350, black

**Part leather equipment**

for standard seats, front without seat ventilation: seat centre panels of front seats and the two outer rear seats and the door sill bolster on the driver side in leather; seat side bolsters, centre rear seat, head restraints, door trim inserts and centre armrest, front (if ordered) in synthetic leather

**For standard seats, front with seat ventilation:**

seat centre panels of front seats and seat centre panels without ventilation of the two outer rear seats in perforated leather, and the entrance bolster on the driver side in leather; seat side bolsters, centre rear seat, head restraints, door trim inserts and centre armrest, front (if ordered) in synthetic leather

**Alcantara/leather combination**

exclusive, sporty look for sport seats; high seating comfort and a good seating climate thanks to rapid temperature equalisation; particularly hard-wearing, easy to clean and resistant to wear and tear. The Alcantara seat centre panels provide good support, making them especially suitable for dynamic driving styles. Seat side bolsters made from the finest leather complete the look

**For sport seats, front and S sport seats, front:**

seat centre panels and door trim inserts in Alcantara, and seat side bolsters, head restraint centre panels, centre armrest, front (if ordered) and lower part of centre console in leather

**Milano leather upholstery and trim**

Extremely hard-wearing and durable leather that gives a high-quality impression with its fine, grained surface. Fully penetrated with dye and tanned without the use of chromium, the leather provides outstanding surface protection thanks to the paint finish.

**For standard seats, front without seat ventilation:**

seat centre panels, seat side bolsters, head restraint centre panel and centre armrest, front (if ordered) in Milano leather

**For standard seats, front with seat ventilation:**

seat centre panels of front seats and seat centre panels without ventilation of the two outer rear seats in perforated Milano leather: seat side bolsters, centre rear seat, head restraints and centre armrest, front (if ordered) in Milano leather

**For sport seats, front:**

seat centre panels, seat side bolsters, head restraint centre panels and centre armrest, front (if ordered) in Milano leather

**Valcona leather upholstery and trim**

high-quality leather that contributes to the elegant charisma of the interior. The sparing use of lacquer allows the material to breathe whilst the non-grained surface underlines the sophisticated character. Tanned without the use of chromium, dyed through and treated with non-fading colour pigments

**For individual contour seats, front without seat ventilation:**

seat centre panels, seat side bolsters, head restraints, door trim inserts and centre armrest, front (if ordered) in Valcona leather; lower part of centre console in leather

**For individual contour seats, front with seat ventilation:**

seat centre panels of front seats and seat centre panels without ventilation of the two outer rear seats in perforated Valcona leather: seat side bolsters, centre rear seat, head restraints, door trim inserts and centre armrest, front (if ordered) in Valcona leather; lower part of centre console in leather

**For sport seats, front:**

seat centre panels, seat side bolsters, head restraints, door trim inserts and centre armrest, front (if ordered) in Valcona leather; lower part of centre console in leather

**For S sport seats, front:**

seat centre panels, seat side bolsters, head restraint centre panels, armrests in doors, door trim inserts and centre armrest, front (if ordered) in Valcona leather; lower part of centre console in leather

**Audi exclusive leather upholstery and trim (package 1) in Valcona leather\***

Seat centre panels, seat side bolsters, head restraints, door trim inserts, centre armrest, front (if ordered) and lower part of centre console in Valcona leather. Individual choice of colour for the leather and the stitching from the range of Audi exclusive colours

**Audi exclusive leather upholstery and trim (package 2) in Valcona leather\***

In addition to package 1: armrests in the door trims and seat backrest covers in leather. Individual choice of colour for the leather and the stitching from the range of Audi exclusive colours. Seat attachments in matching colour to leather

**Audi exclusive leather upholstery and trim (package 1) in Alcantara/Valcona leather\***

Seat centre panels and door trim inserts in Alcantara; seat side bolsters, head restraints, centre armrest, front (if ordered) and lower part of centre console in Valcona leather. Individual choice of colour for the Alcantara, the leather and the stitching from the range of Audi exclusive colours

**| Leather packages****Leather-covered armrests in the door trims**

Leather package  
armrests in the door trims, door pull handles and lower part of centre console in leather

**Leather package including airbag cover<sup>1</sup>**

armrests in the door trims and door pull handles in leather; steering wheel airbag cover in black leather; leather trim for the lower part of the centre console, if not already included with the selected equipment

**Audi exclusive leather package including airbag cover<sup>1</sup> as leather package including airbag cover.**

Individual choice of colour for the leather and the stitching from the range of Audi exclusive colours. Additionally, leather trim for the lower part of centre console, if not already included with the selected equipment

**Extended Audi exclusive leather package<sup>1</sup>**

Dashboard underside including glove compartment, armrests in the door trims, centre console, as well as lower part of centre console in leather. Individual choice of colour for the leather and the stitching from the range of Audi exclusive colours. Steering wheel airbag cover in black leather

**Audi exclusive piping for individual contour seats<sup>1</sup>**

Individual choice of colour for the piping from the range of Audi exclusive colours. Can only be ordered in conjunction with Audi exclusive Valcona leather upholstery and trim package 1 or 2

**Audi exclusive leather-covered seat trim<sup>1</sup>**

for individual contour seats, front with memory function, electrically adjustable: seat side trims and trims, front in fine Nappa leather.

For sport seats, front and S sport seats, front: seat side trims and trims of extendable thigh support in fine Nappa leather; seat side trims with stitching; switches and handles for seat adjustment in black (not in leather).

Individual choice of colour for the leather and the stitching from the range of Audi exclusive colours.

**| Seat comfort****Front seats, electrically adjustable, including memory function for the driver seat**

with electric adjustment of seat height, fore/aft position, seat and backrest angle and electric 4-way lumbar support; 2 presets for the electrically adjustable driver seat and exterior mirrors

**Seat heating, front**

heats the seat and backrest centre panels, for leather upholstery and trim and sport seats also heats the seat side bolsters; separately adjustable in several stages for driver and front-passenger side

**Seat heating, front and rear**

functions as for seat heating, front, also for the outer rear seats, can be adjusted separately in several stages

**Seat ventilation, front**

using a fan for standard seats or by drawing in air on individual contour seats, the system ensures a pleasant seating climate can be enjoyed even at high ambient temperatures; seat ventilation of seat and backrest centre panels and thigh support of driver and front-passenger seat (adjustable in 3 stages); undercooling protection by automatic heating of seat heating. If seat ventilation, front is fitted, the leather on the front and outer rear seats is perforated.

**Massage function, front**

massages the muscles of driver and front passenger using 10 pneumatic cushions; 5 different programs (Wave, Tapping, Stretch, Back, Shoulder), each offering 5 levels of intensity; selection via multifunction switches on the seat or via the optional MMI; display in the MMI

**Centre armrest, front**

with adjustable angle and is adjustable lengthways, with fold-open storage compartment (with automatic transmission)

**| Seats in the rear****Rear seat system**

3 seats, visually adapted to the front seats; 3 L-shaped head restraints, rear, height manually adjustable; rear seat backrest can be split-folded 40:60 or fully; in A6 Avant and A6 allroad quattro with remote backrest release in luggage compartment; including fold-out centre armrest with storage compartment

**| Headlinings****Headlining in cloth, black**

only available in conjunction with black dashboard

**Headlining in Alcantara, black<sup>1</sup>**











headlining, upper pillar trim, parcel shelf and sun visors in Alcantara, black, stitching in black; in A6 Saloon parcel shelf additionally in Alcantara, black



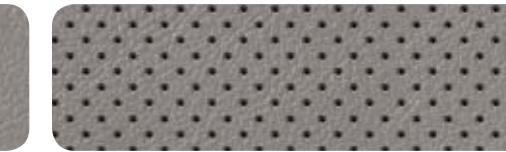





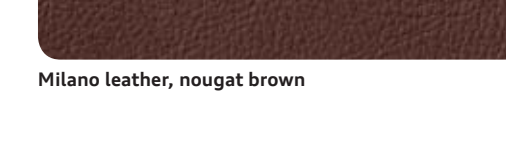
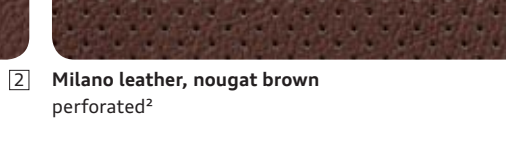
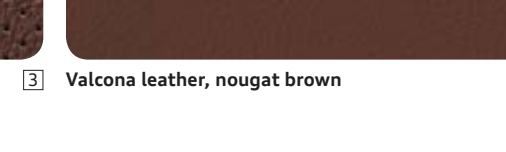
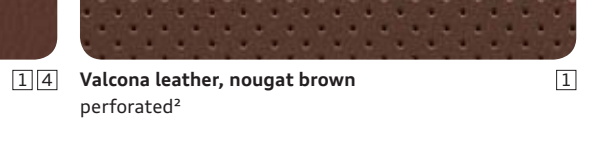

**Headlining in Alcantara black with coloured Audi exclusive stitching<sup>1</sup>**

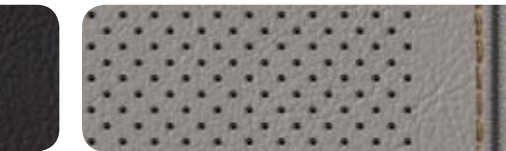
headlining, upper pillar trim and sun visors in Alcantara, black, decorative stitching in black; in A6 Saloon parcel shelf additionally in Alcantara, black. Individual choice of colour for the stitching from the range of Audi exclusive colours.

<sup>1</sup>From quattro GmbH.

<p><b>  Cloth</b></p>  <p>Effect cloth, black only available for A6 allroad quattro</p>	<p><b>  Part leather</b></p>  <p>Part leather, black</p>	 <p>Part leather, black perforated<sup>2</sup></p>	<p><b>  Alcantara/leather</b></p>  <p>Alcantara/leather, black</p>
 <p>Sierra cloth/mono.pur 350 only available for A6 allroad quattro</p>	 <p>Part leather, flint grey</p>	 <p>Part leather, flint grey perforated<sup>2</sup></p>	 <p>Alcantara/leather, flint grey</p>
 <p>Contour cloth</p>	 <p>Part leather, Atlas beige</p>	 <p>Part leather, Atlas beige perforated<sup>2</sup></p>	 <p>Alcantara/leather, lunar silver only available for S6 Saloon and S6 Avant</p>
<p><b>  Cloth/leather</b></p>  <p>Sequence cloth/leather, black with contrasting stitching. Only available in conjunction with S line sport package</p>	 <p>Part leather, nougat brown</p>	 <p>Part leather, nougat brown perforated<sup>2</sup></p>	 <p>Perforated Alcantara/leather, black with contrasting stitching. Only available in conjunction with S line sport package</p>

<p><b>  Leather</b></p>  <p>Milano leather, black</p>	 <p>Milano leather, black perforated<sup>2</sup></p>	 <p>Valcona leather, black</p>	 <p>Valcona leather, black perforated<sup>2</sup></p>
 <p>Milano leather, flint grey</p>	 <p>Milano leather, flint grey perforated<sup>2</sup></p>	 <p>Valcona leather, flint grey</p>	 <p>Valcona leather, flint grey perforated<sup>2</sup></p>
 <p>Milano leather, Atlas beige</p>	 <p>Milano leather, Atlas beige perforated<sup>2</sup></p>	 <p>Valcona leather, Atlas beige</p>	 <p>Valcona leather, Atlas beige perforated<sup>2</sup></p>
 <p>Milano leather, Santos brown only available for A6 allroad quattro</p>	 <p>Milano leather, Santos brown perforated<sup>2</sup>, only available for A6 allroad quattro</p>	 <p>Valcona leather, Santos brown only available for A6 allroad quattro</p>	 <p>Valcona leather, Santos brown perforated<sup>2</sup>, only available for A6 allroad quattro</p>

<p><b>  Leather</b></p>  <p>Milano leather, black with contrasting stitching. Only available for A6 allroad quattro</p>	 <p>Valcona leather, black<sup>3</sup> in S6 Saloon and S6 Avant with contrasting stitching</p>	<p><b>  Audi design selection</b></p>  <p>Valcona leather, flint grey perforated, with contrasting stitching</p>	<p><b>  Audi exclusive line</b></p>  <p>Valcona leather, alabaster white<sup>4</sup> perforated, with contrasting stitching</p>
 <p>Valcona leather, black with contrasting stitching. Only available for A6 allroad quattro</p>	 <p>Valcona leather, lunar silver<sup>2</sup> in S6 Saloon and S6 Avant with contrasting stitching</p>	 <p>Valcona leather, Arras red with diamond pattern and contrasting stitching Only available for S6 Saloon and S6 Avant</p>	<p><b>  Audi exclusive</b></p>  <p>Audi exclusive leather upholstery and trim<sup>1</sup> Individual choice of colour for leather/stitching/piping</p>
 <p>Valcona leather, Atlas beige with contrasting stitching. Only available for A6 allroad quattro</p>	 <p>Valcona leather, Santos brown with contrasting stitching. Only available for A6 allroad quattro</p>		<p><b>  Seat options</b></p> <ul style="list-style-type: none"> <li><sup>1</sup> Customised contour seats, front</li> <li><sup>2</sup> Standard seats, front without seat ventilation</li> <li><sup>3</sup> Standard seats, front with seat ventilation</li> <li><sup>4</sup> Sport seats, front</li> <li><sup>5</sup> S sport seats, front</li> </ul>

The model-specific standard and optional equipment can be found in the index from page 114 onwards.

<sup>1</sup> From quattro GmbH. <sup>2</sup> Only available in conjunction with seat ventilation, front. <sup>3</sup> In A6 Saloon and A6 Avant only in conjunction with S line sport package and without contrasting stitching.

## Experience fascination. Down to the last detail.

Exclusive ambience is a question of style. Your style. A style you can refine right down to the last detail. Create tangible accents with high-quality Audi inlays. Take pleasure in smooth wood that radiates a natural warmth. Experience the fascination of open-pore wood whose exclusivity you can literally feel. Or make a personal statement with combinations of fine woods and aluminium trim – and allow your own personal taste to determine the character.

Full-surface inlays for the dashboard, centre console and door trims.



### | Inlays



**Satin finish, silver-grey**  
for interior equipment in flint grey and black



**Satin finish, silver-beige**  
for interior equipment in Atlas beige and nougat brown



**Matt brushed aluminium**  
all-round inlay and surrounds of door trims in aluminium look. For A6 Saloon and A6 Avant only in conjunction with S line sport package

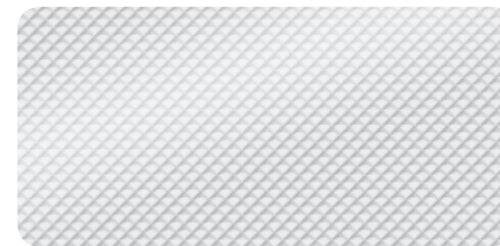

**aluminium delta, silver**  
all-round inlay and surrounds of door trims in aluminium look



**Aluminium delta, bronze**  
all-round inlay and surrounds of door trims in aluminium look. For interior equipment in Atlas beige and Santos brown. Only available for A6 allroad quattro



**piano finish, black<sup>1</sup>**  
all-round inlay and surrounds of door trims and centre console in aluminium look



**walnut, dark brown**  
all-round inlay and surrounds of door trims and centre console in aluminium look



**Eucalyptus, natural<sup>1</sup>**  
all-round inlay and surrounds of door trims and centre console in aluminium look. Only available in conjunction with Audi exclusive line



**fine grain ash, natural brown**  
all-round inlay and surrounds of door trims and centre console in aluminium look



**Beaufort walnut**  
all-round inlay and surrounds of door trims and centre console in aluminium look

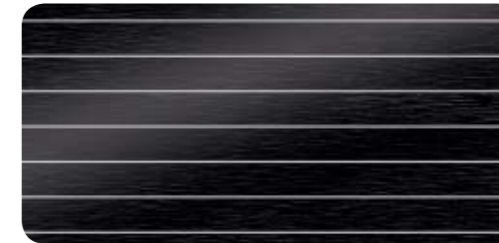

**aluminium/Beaufort, black<sup>1</sup>**  
all-round inlay and surrounds of door trims and centre console in aluminium look



**fine grain ash, natural brass**  
all-round inlay and surrounds of door trims and centre console in aluminium look. Only available in conjunction with Audi design selection, flint grey

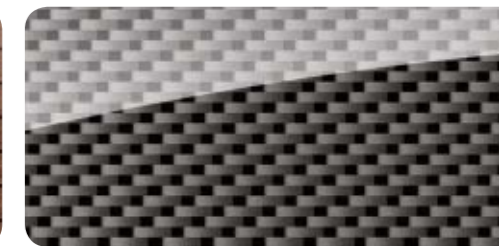

**Carbon Atlas**  
all-round inlay and surrounds of door trims and centre console in aluminium look. Only available for S6 Saloon and S6 Avant



**carbon twill, red**  
all-round inlay and surrounds of door trims and centre console in aluminium look. Only available in conjunction with Audi design selection, Arras red



**Audi exclusive inlays in wood<sup>1,2</sup>**  
all-round inlay and surrounds of door trims and centre console in aluminium look

The model-specific standard and optional equipment can be found in the index from page 114 onwards.

<sup>1</sup>From quattro GmbH. <sup>2</sup>Available in fine grain ash, nougat, oak sepia, fine grain myrtle, nutmeg, vavona, bronze, modrone, gold, tamo ash, natural dark brown.

| **Headlights****Xenon plus**

intensive road illumination, good uniformity and range thanks to headlights with durable gas discharge technology for dipped and high beam. Automatic dynamic headlight beam prevents oncoming traffic from being dazzled. Integrated LED daytime running light strip and all-weather light. For A6 allroad quattro including headlight cleaning system

**High-beam assist**

improves the driver's visibility and ensures a more relaxed drive thanks to extra comfort and convenience. Depending on the traffic situation, the high beam automatically adjusts to dipped beam and vice versa. Working within system limits, it automatically detects the headlights of oncoming traffic, the rear lights of other road users and light sources from built-up areas. In conjunction with the optional night vision assistant, the networked vehicle functions support the marking light for detected pedestrians for more safety when driving at night.

**LED headlights**

allow precise, near daylight illumination of the road; combine dipped beam, high beam, daytime running lights, motorway light, indicators and static turning light, as well as all-weather light in LED technology; including headlight cleaning system, motorway light that automatically increases headlight range from a speed of approx. 110 km/h; all-weather light to reduce the risk of the driver being dazzled when visibility is poor; striking light pattern in day and night design configurations with low energy consumption and long service life

**Audi Matrix LED headlights**

This innovative technology combines a camera system with LED light sources and precision optics for highly adaptive light distribution. The system blanks out light that would otherwise shine directly on oncoming vehicles or vehicles in front, but continues to fully illuminate all the other areas in between and alongside. The front lighting thus adapts dynamically, providing the driver with a much wider visual range. The conventional division between dipped and high beam is dispensed with. Familiar convenience functions, such as the static turning light, all-weather light, junction light, motorway light and travel mode, which uses GPS data to switch between right- and left-hand drive modes, are integrated into the LED technology. The LEDs of the Audi Matrix LED headlights also perform the dynamic cornering light functions. Using vehicle support based on navigation data, the cornering light starts responding shortly before the steering wheel is turned. The marking light cooperates with the optional night vision assistant. If pedestrians are detected, individual LEDs flash briefly three times in succession to mark out the pedestrians clearly from their surroundings. Distinctive features include the crisp lighting pattern, the LED daytime running lights and the dynamic indicators in the headlights and rear lights. Including headlight cleaning system

**LED rear lights**

brake, tail, rear fog, indicator and rear number plate lights in low-energy LED technology; with reversing lights

**LED rear lights with dynamic indicator**

same functions as the LED rear lights, additionally featuring a dynamic and easily recognisable lighting pattern for the indicators. The segments of the LED light band are illuminated in turn within milliseconds, creating a pulse of light that runs outwards in the direction in which the car is turning. When operated, the indicators send a distinctive signal to other road users

| **Interior lighting****Ambient lighting**

with integrated eyewear compartment in the roof module; additional to the interior and exterior lighting package, anti-glare lighting for the passenger compartment in LED technology:

- interior lighting, front and rear, including reading lights
- illuminated vanity mirror
- ambient lighting for centre console
- lighting for door pockets
- illuminated door sill trims (with selection of S line packages door sill trims are without S line logo)

Configured via MMI

**Interior and exterior lighting package**

Interior lighting: ambient reflected lighting for door inner panels to help occupants better orient themselves, as well as front and rear entrance light in LED technology; illuminated vent controls

Exterior lighting: courtesy lighting on the undersides of the door handles, LED door handle lighting to facilitate entry and exit in the dark; active door reflectors (light bulbs)

Light Design Steering wheels/controls Comfort Infotainment Assistance systems Technology/safety Audi Extended Warranty

| **Exterior design****Aluminium-look exterior**

roof rails with double bars, roof frame and window slot trim in anodised aluminium, door handles and rear feature trim strips in aluminium look, sill extensions with stainless steel inlays

**Gloss package**

window slot trim in anodised aluminium, B-pillar trim outside in high-gloss black

**Exhaust tailpipes**

dual-branch design, 1 tailpipe each left and right with trapezoidal chrome-plated trims; on A6 allroad quattro in allroad-specific design

**Model name/logo**

A6 Saloon/Avant:  
A6 logo, ultra emblem (on A6 2.0 TDI and 1.8 TFSI ultra) and TDI, FSI or TFSI logo on luggage compartment lid, each can be omitted on request

A6 allroad quattro:

A6 allroad quattro logo on luggage compartment lid, can be deselected optionally

**Roof rails**

for safe transportation of items, strong and aerodynamically shaped, in anodised aluminium; on A6 allroad quattro in black with double-bar design

| **Interior design****Door sill trims with aluminium inlays****Vimentum floor mats**

in high-quality jacquard fabric front and rear, matched to the selected interior colour

**Audi exclusive floor mats\***

individual choice of colour for floor mats, leather piping and stitching from the Audi exclusive range of colours

**Audi exclusive carpet and floor mats\***

individual choice of colour for the carpet, the floor mats, the leather piping and the stitching from the range of Audi exclusive colours

## | Steering wheels/controls



**Multifunction sport leather steering wheel in 3-spoke design with shift paddles**  
as multifunction sport leather steering wheel in 3-spoke design, additionally with shift paddles for manually changing gears with automatic transmission; on A6 allroad quattro with allroad emblem

**Multifunction sport leather steering wheel in 3-spoke design**  
for operating the provided infotainment features; adjustable in height and reach, with full-size airbag; matched to the selected colour of the upper dashboard; on A6 allroad quattro with allroad emblem

**Multifunction sport leather steering wheel in 3-spoke design with shift paddles, heated**  
as multifunction sport leather steering wheel in 3-spoke design with shift paddles, additionally heated steering wheel rim; on A6 allroad quattro with allroad emblem

**Multifunction leather steering wheel in 4-spoke design**  
for operating the provided infotainment features; adjustable in height and reach, with full-size airbag; matched to the selected colour of the upper dashboard



**Multifunction leather steering wheel in 4-spoke design with shift paddles**  
as multifunction leather steering wheel in 4-spoke design, additionally with shift paddles for manually changing gears with automatic transmission

**Multifunction leather steering wheel in 4-spoke design, heated**  
as multifunction leather steering wheel in 4-spoke design, additionally heated steering wheel rim

**Electric steering wheel adjustment**  
adjustable in height and reach, with automatic entry and exit function; additionally with memory function if ordered with front seats, electrically adjustable

**Steering wheel rim with wooden segments\***  
for multifunction leather steering wheel in 4-spoke design with shift paddles; available in walnut, dark brown



**Audi exclusive steering wheel rim with wooden segments\***  
for multifunction leather steering wheel in 4-spoke design with shift paddles; customised with wood (not available in tamo ash, natural dark brown) and Audi exclusive leather. Individual choice of colour for the leather and the stitching from the range of Audi exclusive colours

**Audi exclusive leather steering wheel rim\***  
Steering wheel rim in leather. Individual choice of colour for the leather and the stitching from the range of Audi exclusive colours. Stitching with specific Audi exclusive seam detail

**Audi exclusive leather controls\***  
Leather-covered steering wheel rim, gear/selector lever knob and gaiter. Individual choice of colour for the leather and the stitching from the range of Audi exclusive colours. Stitching on the steering wheel rim with specific Audi exclusive seam detail

**Gear/selector lever knob in leather**  
colour-coordinated with the selected vehicle interior colour and to match the upper dashboard

**Audi exclusive aluminium gear lever knob\***

## | Mirrors

**Exterior mirrors with integrated LED indicator**  
electrically adjustable and heated, convex, flat or aspherical mirror glass; additionally with memory function if front seats, electrically adjustable, are ordered; body-coloured housing

also optionally:

**electrically folding**  
including automatic kerb-side function for the exterior mirror on the passenger side

**automatically dimming on both sides**  
including automatic kerb-side function for the exterior mirror on the passenger side

**electrically folding and automatically dimming on both sides**  
including automatic kerb-side function for the exterior mirror on the passenger side

The automatic kerb-side function tilts the exterior mirror on the passenger side downwards when reverse gear is selected, giving the driver a better view of the kerb.

## | Roof systems



**Panoramic glass sunroof**  
2 sections; electrical activation to raise and open the front glass section; with tinted glass insert and electrically operated sunblind and convenience closing/opening via the vehicle key; provides an interior flooded with light; improves the interior climate by efficient ventilation

**Slide-and-tilt glass sunroof**  
electric, with tinted single-pane safety glass and infinitely adjustable sun shield; including integrated wind deflector, convenience closing/opening from outside via the vehicle key

## | Glazing



**Dark-tinted windows (privacy glazing)**  
dark-tinted rear window, rear door windows and rear side windows

**Heat-insulating glass**  
tinted green, windscreen and front door windows in acoustic glazing for improved exterior noise insulation; rear window heated, with timer

**Insulating/acoustic glass**  
provides improved exterior noise insulation and theft protection thanks to the 2 panes of glass bonded together by a plastic film. Additional reflective coating reduces build-up of heat in the interior. Windscreen with viewing window for toll collection devices; rear window in standard glass on A6 Avant and A6 allroad quattro

**Insulating/acoustic glass and dark-tinted windows (privacy glazing)**  
Windscreen and front door windows in insulating/acoustic glass; dark-tinted rear window, door windows and rear side windows; windscreen with viewing window for toll collection devices; rear window in standard glass on A6 Avant and A6 allroad quattro

**Sunblinds**  
manually operated for the rear window and the rear door windows; on the A6 Saloon electric for the rear window and manual for the rear door windows

## | Climate control



**4-zone deluxe automatic air conditioning**  
in addition to deluxe automatic air conditioning: front air-conditioning controls with digital display, additional air-conditioning controls with digital display for climate control in the rear with separately adjustable temperature for the left- and right-hand sides as well as blower settings and air distribution (rear-compartment A/C functions can also be adjusted from the front air-conditioning controls), additional air vents in the B pillars, automatic recirculation mode by means of air quality sensor, use of residual heat, separate regulation of footwell temperature, ventilated glove compartment. Choice of 3 climates: gentle, medium and intensive



**Deluxe automatic air conditioning**  
electronically regulates the air temperature, flow rate and distribution, separate temperature control for driver and front-passenger sides; with ventilation via defroster nozzles for front and side windows; automatic recirculation mode, sunlight-dependent control and combined/fine particulate filter; with humidity sensor and key-coded settings; ventilation in the rear via centre console

## | Climate control

**Auxiliary heating/ventilation**

The auxiliary heating warms up the interior and removes ice from the windows without starting the engine. The auxiliary ventilation system supplies fresh air and reduces the temperature of the interior. A smart control function with timer and departure time programming calculates time- and energy-efficient duration for heating. Separate radio-operated remote control with illuminated display; choice of 2 heating modes: “defrost” (defrosting mode only for the windows), “warm” (warming up mode that also preheats the interior)

## | Closing systems

**Convenience key**

access and drive authorisation system in which the vehicle key only needs to be carried with you; the engine is started and switched off via the engine start-stop button; the vehicle is locked and unlocked from outside via sensors on all door handles; door handles feature trim strips in aluminium look, in conjunction with Audi exclusive black gloss package black door handles in body colour; on A6 allroad quattro trim strips in aluminium look only in conjunction with aluminium-look exterior; the luggage compartment lid can also be opened separately when the vehicle is locked

**Luggage compartment lid, automatically opening**

The luggage compartment lid automatically swings open when the luggage compartment is opened via the vehicle key or by activating the soft-touch release on the luggage compartment lid. Manual closing of luggage compartment lid

**Luggage compartment lid, electrically opening and closing**

opened with the button on the vehicle key or in the driver door or the soft-touch button in the handle recess of the luggage compartment lid; with the optional convenience key including sensor-controlled release of luggage compartment lid also by a foot gesture (kicking movement); closing via button on the inside of the luggage compartment lid, button in the driver door or the optional convenience key (long press). In conjunction with the convenience key, it is possible to close the luggage compartment lid and simultaneously lock the car via an additional button on the inside of the luggage compartment lid. Includes power assisted closing; on A6 Avant and A6 allroad quattro including programmable opening angle of the luggage compartment lid and electrically opening and closing luggage space cover, also manually operated

**Power-assisted door closing**

automatically pulls the doors into the locks when not fully closed

**Convenience key including sensor-controlled release of the luggage compartment lid**

items as for convenience key. Automatic opening of the luggage compartment lid via a foot gesture (kicking movement) underneath the rear bumper when the vehicle key is recognised.

**Garage door opener (HomeLink)**

programmable radio-operated remote control with operating buttons integrated into the front roof module, can be used to open many garage doors and exterior gates; allows control of security and lighting systems; code identification guidance and set-up assistance through the optional MMI navigation plus. Please contact your Audi partner or visit [www.eurohomelink.com](http://www.eurohomelink.com) for further information.

**Anti-theft alarm**

monitors doors, bonnet and luggage compartment lid; includes interior monitoring (can be deactivated), tow-away protection via tilt angle sensor and signal horn independent of vehicle electrical system; with safety guarantee: prevents doors being opened from the inside once the vehicle has been locked using the radio-operated remote control

**Preparation for tracking system**

preparation for connecting a tracking system (available from Audi Genuine Accessories) that enables a stolen vehicle to be located and tracked.

## | Storage/transport

**Luggage compartment**

large-volume with large through-load width; includes side net on the right-hand side; with 12V socket in the side panel trim on the right-hand side and bag hooks in the luggage compartment, left and right, and four lashing points on the luggage compartment floor; on A6 Avant and A6 allroad quattro with retaining straps in the luggage compartment, left and right, and trim strip in aluminium look where the bumper meets the luggage compartment opening

**Storage compartments**

Storage compartment in the front and rear door trims, e.g. for bottles up to 1 litre, storage nets on the front seat backrests, storage compartment under the front seats (only with standard seat, sport seat and S sport seat) and in the centre console; glove compartment on the front passenger side, lockable, large, illuminated, with holder for writing utensils; 2 cup holders in the centre console and one 12V socket

**Storage package**

2 cup holders in the centre armrest, rear, luggage compartment net for securing to the lashing points on the luggage compartment floor, additional 12V socket in the rear

**Through-loading facility with removable ski/snowboard bag**

for the practical transportation of long items, e.g. up to 4 pairs of skis or 2 snowboards; ski/snowboard bag removable and secured by a strap

Light Design Steering wheels/controls Comfort Infotainment Assistance systems Technology/safety Audi Extended Warranty

**Load-securing kit**

for the rail system in the luggage compartment, with telescopic rod and attachment strap, for individual partitioning of the luggage compartment and for securing objects

**Rail system**

in the luggage compartment; including 4 lashing points for securing loads, suitable for individual positioning in the rail system

**Partition net**

removable; for fastening to the bodywork or to the folded-down rear seats, practical when the rear seats are up or folded down on one side, as well as when both rear set backrests are folded down

**Loading floor**

with dirt collecting tray beneath, easy to clean; ideal for the transportation of soiled items; in conjunction with with the optional spare wheel or collapsible spare wheel or the optional adaptive air suspension, the dirt collecting tray is replaced with a dirt cover

**Reversible mat**

to cover the luggage compartment, also with the rear seat backrest folded down; velour on one side, rubber on the other; on A6 Avant and A6 allroad quattro with fold-out cover for loading sill and bumper

**Non-smoker version**

one storage compartment in the front as well as one 12V socket in the rear instead of the cigarette lighter

**Provision for trailer towing hitch**

includes preparation for the control units and reinforced engine cooling. The trailer towing hitch for retrofitting is available from Audi Genuine Accessories.

**Trailer towing hitch**

mechanically swivelling, ball joint coupling and ball head made from forged steel; operated via draw-button in luggage compartment, with control light in luggage compartment and display in instrument cluster to monitor secure attachment of the trailer; trailer stabilisation system via the Electronic Stabilisation Control (ESC). The integrated swivelling system socket enables continuous operation of electrical equipment in the trailer or caravan during a journey.

## | MMI®/navigation

**Driver information system**

displays a host of useful information on a 5-inch TFT monochrome display in the driver's direct field of vision. Attention assist provides a warning in the driver information system and via acoustic signal if the system determines that the driver's attention is lapsing. The system is active between 65 and 200 km/h and can be deactivated. An integrated efficiency program provides consumption data overviews.

**Driver information system with colour display**

shows the information of the driver information system on a high-resolution 7-inch colour display with an even better overview and readability; additional display of information of driver assistance systems and other display contents from the MMI system such as navigation, night vision assistant and phone menu (if fitted)

| **MMI®/navigation****MMI® navigation**

- with navigation data (SD card)<sup>1</sup>
- electrically extending 6.5-inch colour display with map representation and numerous detailed display options
- dynamic route guidance with TMC (where available)
- voice control (entry of destination by whole-word entry)
- additional arrow display in the driver information system
- MMI radio plus
- CD player and 2 SDHC card readers (up to 32 GB), each MP3, WMA and AAC compatible
- Audi music interface for the connection of portable media players such as Apple iPod, Apple iPhone (music functionality) as well as USB storage media and MP3 players (can only be used with a special Audi Genuine Accessories adapter cables)
- Bluetooth interface for hands-free mode and audio streaming
- Audi sound system

**MMI® navigation plus with MMI touch**

- Navigation system<sup>1</sup> including map updates<sup>2</sup>
- electrically extending high-resolution 8-inch colour display
- 3D map representation with display of lots of sightseeing information and city models
- detailed route information: map preview, choice of alternative routes, POIs, lane recommendations, motorway exits, detailed junction maps etc.
- MMI touch: touch-sensitive control panel for fast, intuitive operation e.g. destination entry by means of handwriting recognition as well as free movement and zooming in the map
- voice control system with whole-word entry of address in one sentence
- access to smartphone voice control
- driver information system with 7-inch colour display including navigation map view
- dynamic route guidance with TMCpro (in conjunction with Audi connect: traffic information online)
- vehicle support based on navigation data and speed limit display
- country information, e.g. on valid speed limits, motorway sticker requirement when passing the border, etc.
- myAudi special destinations: importing individual point-of-interest (POI) lists to the vehicle via the myAudi portal
- MMI radio plus
- Audi sound system
- flash memory for music (10 GB)
- DVD drive (MP3, WMA, AAC and MPEG-4 compatible), can be used for music CDs and video DVDs
- 2 SDXC card readers
- Audi music interface for the connection of portable medial players via USB interface (including power supply/charging function) or Wi-Fi
- Bluetooth interface for hands-free mode and audio streaming
- display of emails and messages from mobile phone in selected languages including read-out function<sup>3</sup>
- use of services supported by Audi connect<sup>4</sup>

| **Entertainment****MMI® radio**

- MMI control concept with electrically extending 6.5-inch colour display, separate MMI control panel and car menu
- CD player (MP3 and WMA compatible), AUX-IN connection, USB charging function
- radio with phase diversity
- 8 passive loudspeakers, front and rear, total output 80 watts

**MMI® radio plus**

- MMI control concept with electrically extending 6.5-inch colour display, separate MMI control panel and car menu
- driver information system
- CD player and 2 SDHC memory card readers (up to 32 GB), each MP3, WMA and AAC compatible
- Audi music interface for the connection of portable media players such as Apple iPod, Apple iPhone (music functionality) as well as USB storage media and MP3 players (can only be used with a special Audi Genuine Accessories adapter cables)
- radio with phase diversity, TP memo (automatically saves traffic news when driving)
- voice control
- Bluetooth interface for hands-free mode and audio streaming
- Audi sound system

**Digital Audio Broadcasting**

In addition to the range of analogue stations, programmes from digitally broadcast radio stations can be received according to DAB standard, including DAB+ and DMB audio; display of additional information accompanying the programme (e.g. artist, title, depending on provision by the respective radio station) and additional information in the form of a slide show (e.g. cover and weather)

**Digital TV reception**

reception of digitally broadcast, uncoded television stations<sup>5</sup> (in DVB-T and DVB-T2 standard with MPEG-2 or MPEG-4 video coding), and DVB-T audio stations; display of additional information accompanying the programme such as teletext, subtitles and Electronic Programme Guide (EPG); automatic station search; external AV-IN connection via adapter cable; no picture possible when the vehicle is moving

**Audi music interface**

Portable media players<sup>6</sup> such as Apple iPod/iPhone (music functionality) and USB storage media and MP3 players can be connected to the vehicle. Located in the centre console; operation via MMI or multifunction leather steering wheel. Special Audi Genuine Accessories adapter cables for connecting portable media players or USB storage media are required with the equipment MMI radio plus or MMI navigation. From MMI navigation plus the Audi music interface has 2 USB connections. Part of MMI radio plus, MMI navigation and MMI navigation with MMI touch

**Adapter cable set for Audi music interface**

consists of 2 connecting cables to connect Apple iPod/iPhone with dock connection (e.g. iPhone 4) as well as data storage devices/media players<sup>6</sup> with USB port (type A); other adapter cables are available from Audi Genuine Accessories

**Adapter cable set plus for Audi music interface**

In addition to the adapter cable set for Audi music interface, the display of cover art and video functions is possible in conjunction with Apple iPhone and more recent generations of Apple iPod<sup>6</sup> – depending on the device used.

**Audi sound system**

impressive sound thanks to 6-channel amplifier with a total output of 180 watts and 10 loudspeakers including centre speaker and subwoofer

**CD changer**

for 6 CDs (MP3 and WMA compatible); shock-resistant location in the glove compartment; can be operated via MMI

**DVD/CD changer**

for 6 DVDs or CDs; supports audio CDs and video DVDs; shock-resistant location in the glove compartment; can be operated via MMI

**Bose Surround Sound**

impressive surround sound reproduction thanks to 12-channel amplifier with a total output of 600 watts and 14 loudspeakers including centre speaker and subwoofer; AudioPilot<sup>®</sup> for noise-dependent volume adjustment and reproduction of 5.1 surround sound in conjunction with MMI navigation plus with MMI touch; powerful and accurate bass reproduction, lifelike sound with natural tone and a feeling of space for an impressive sound experience

**Bang & Olufsen Advanced Sound System**

captivating surround sound reproduction with 15 loudspeakers including centre speaker and subwoofer – each with its own amplifier channel. The efficient 15-channel DSP all-digital amplifier with 5 integrated ICE Power output stages for woofers and subwoofers has a total output of more than 1,200 watts. Reproduction of 5.1 surround sound is possible in conjunction with the optional MMI navigation plus with MMI touch. Polished loudspeaker covers in aluminium and automatically extending acoustic lenses for excellent sound performance and perspective in any seat; noise-dependent volume adjustment. Privacy function provided by encapsulated loudspeaker casings which minimise the escape of sound to the outside of the vehicle and provide privacy, for example when making phone calls.

**Preparation for Rear Seat Entertainment**

includes pre-installation wiring and mounts for the holders in the driver and front-passenger seat backrests. The appropriate Audi Entertainment mobile devices (9-inch screen with integrated DVD player) and the holder or Apple iPad adapter are available from Audi Genuine Accessories as a plug-and-play unit (see also page 101).

## | Communication

### Audi connect

convenient connection of your vehicle to the internet for the use of Audi connect via an integrated data module with LTE<sup>1</sup>/UMTS support. There is a SIM card reader in the surround of the MMI navigation plus with MMI touch.

The following services supported by Audi connect are available in your model:

### Communication

- Access to smartphone voice control<sup>2</sup>
- Wi-Fi hotspot
- Messages (SMS)<sup>3,7</sup>
- Access to Facebook
- Access to Twitter

### Mobility & navigation

- Map update online<sup>4</sup>
- Point-of-interest (POI) search
- Traffic information online
- Navigation with Google Earth™<sup>5</sup> and Google Street View™<sup>5</sup>
- Destination entry via myAudi or Google Maps™<sup>5</sup>
- Picturebook navigation
- Flight information
- Train information
- Fuel prices
- Parking information

### Infotainment

- Weather
- Online media streaming<sup>6</sup>
- News online (individual)
- City events
- Travel information

In conjunction with the optionally available equipment Audi phone box, Audi connect includes a car phone function via SIM card slot or SAP profiles.

Use of the services supported by Audi connect is possible only with the optional MMI navigation plus with MMI touch and Audi connect. You also require a SIM card with data option and with LTE option<sup>1</sup> to use LTE. The services are available only in conjunction with an existing or separate mobile phone contract and only within the range of the respective mobile phone network. Additional costs may be incurred when receiving data packets from the internet, depending on the terms of your mobile phone contract, particularly when used abroad. Because of the high data volumes involved, a data flat rate is strongly recommended.

The availability of the services supported by Audi connect varies from country to country. Audi connect services are provided for at least one year from vehicle delivery. 24 months after vehicle delivery, Audi connect services will be extended free of charge once for 12 months. Ask your Audi partner about a subsequent extension of Audi connect services. Audi connect allows access to Facebook, Google and Twitter services. Permanent availability cannot be guaranteed as this is the responsibility of Facebook, Google and Twitter.

Please visit [www.audi.com/connect](http://www.audi.com/connect) or contact your Audi partner for more detailed information about Audi connect; contact your mobile services provider for information about contract conditions.



### Audi phone box<sup>7</sup>

allows phone calls with improved reception quality and charging by placing mobile phone into the front centre console; hands-free facility and voice control (telephone); low SAR radiation inside the vehicle thanks to connection to vehicle aerial; operated via radio/navigation systems or multifunction leather steering wheel; can be charged via USB port. The image on the left shows the Audi phone box for MMI radio plus and MMI navigation; the image on the right shows the Audi phone box for MMI navigation plus with MMI touch.

### Bluetooth interface

allows hands-free calls to be made in the vehicle using the microphone and – depending on mobile phone compatibility<sup>7</sup> – Bluetooth audio streaming. Bluetooth-capable mobile phones can be connected to the vehicle via the interface. Part of MMI radio plus, MMI navigation and MMI navigation plus with MMI touch

## | Assistance systems



### Parking system plus<sup>3</sup>

Acoustic and visual parking system, front and rear, assists with parking and manoeuvring. Display on MMI screen; measurement by ultrasonic sensors integrated discreetly in the bumpers; is also available with optional reversing camera or 360 degree cameras; activated when reverse gear is selected or via a button on the centre console

### Hold assist<sup>8</sup>

holds the vehicle stationary for unlimited periods after stopping in traffic on normal uphill or downhill gradients. The system is activated by push-button and allows the driver to drive away smoothly.

### Hill descent control<sup>8</sup>

maintains selected speed on downhill drives



### Park assist with display of surroundings<sup>8</sup>

searches for suitable parking space along the road by means of ultrasonic sensors and helps you to manoeuvre in and out of parking spaces by performing almost autonomous steering actions. Calculates the ideal parking path for perpendicular parking spaces and the ideal parking and exiting paths for parallel parking spaces. The driver has to accelerate, apply the brakes and monitor the parking process. The display of the surroundings warns the driver of any obstacles at the side of the vehicle, depending on the steering angle. Optionally available in conjunction with reversing camera or 360 degree cameras; activation via a button on the centre console

### Tilt angle display<sup>8</sup>

shows the roll and pitch of the vehicle in the MMI regardless of the acceleration; uses visual signals to inform the driver of a tipping risk when the vehicle tilt exceeds 25° or 35° in 2 levels and automatically starts the hill descent control



### Reversing camera<sup>8</sup>

Image of area behind the vehicle shown on the MMI screen, with dynamic display modes showing the path calculated based on steering angle; auxiliary lines and guidelines as well as display of the point at which to apply opposite lock when parallel parking; reversing camera integrated discreetly in the handle strip of the luggage compartment lid; activated when reverse gear is selected or via a button on the centre console

### Cruise control<sup>8</sup>

At speeds of 30 to 250 km/h, the system keeps the set speed constant provided that engine power and engine braking effect permit it; operated via separate steering column stalk, set speed displayed in driver information system



### 360 degree cameras<sup>8</sup>

safe pulling out of narrow parking spaces. Various display options for the area around the vehicle, including a virtual top view, can be selected on the MMI display. The driver can switch between different image views in the MMI display: reversing image, front camera image, front and rear side view as well as bird's eye view. Includes the features of the reversing camera; activated when reverse gear is selected or via a button on the centre console

### Audi pre sense basic<sup>8</sup>

automatically initiates preventive occupant protection measures if required; these include: belt tensioning, activating the hazard warning lights and closing sunroof (if ordered) and windows; categorises driving situations by networking the different vehicle systems

<sup>1</sup> For information about the availability and use of LTE support, please contact your Audi partner. <sup>2</sup> Requires the optional MMI navigation plus with MMI touch including voice control system and Bluetooth interface and multifunction leather steering wheel. <sup>3</sup> Provided the mobile phone has the Bluetooth protocol MAP (Message Access Profile). <sup>4</sup> The map version delivered can be updated with the first 5 updates that are released at intervals of 6 months. The current navigation data can be downloaded via the myAudi platform at [www.audi.com/myaudi](http://www.audi.com/myaudi) and can be installed via SD card in the vehicle. In conjunction with Audi connect, the update can be carried out online in the vehicle. In addition, it is possible to have the new navigation data installed by an Audi partner at extra cost. <sup>5</sup> Google and the Google logo are registered trademarks of Google Inc. <sup>6</sup> Depending on country-specific availability. You will usually require a media streaming provider account to use this service, which can lead to additional costs. <sup>7</sup> Please contact your Audi partner or visit [www.audi.com/bluetooth](http://www.audi.com/bluetooth) for information on compatible mobile phones. <sup>8</sup> Please note: The systems work only within system limits and assist the driver. However, the driver remains responsible for driving the vehicle and is required to be attentive at all times.



## | Assistance systems



**adaptive cruise control with Stop&Go function including Audi pre sense front<sup>1</sup>** detects vehicles ahead with the aid of radar sensors. The distance from the vehicle ahead is kept more or less constant by braking or accelerating (control range 0–250 km/h). Choice of 4 distance levels/driving modes (efficiency, comfort, dynamic and auto). Including Audi pre sense front: enhanced brake assist warns of any imminent threat of collision with the vehicle in front. Can initiate partial braking action or boost the driver's braking action if necessary. In addition, full braking action is initiated at speeds below 30 km/h if there is danger of collision with a stationary or moving vehicle in order to reduce the speed of the collision or to avoid the collision if possible. Operation of adaptive cruise control via separate steering column stalk. Audi pre sense front can be deactivated via the MMI car menu.



**Audi side assist including Audi pre sense rear<sup>1</sup>** warns by means of an LED display on the relevant exterior mirror of any situations assessed as critical for changing lanes. 2 radar sensors detect vehicles approaching from behind at the side and measure the distance and the difference in speed. The lane change assistant provides assistance in the speed range from around 30 to 250 km/h. To detect a possible rear-end collision, Audi pre sense rear also uses the rear sensors of Audi side assist, in addition to Audi pre sense basic. Activated via a button in the mirror quadrant

**Assistance package including Audi pre sense plus<sup>1</sup>** combines the following assistance systems:

- Parking system plus
- Audi active lane assist
- Audi side assist
- adaptive cruise control with Stop&Go function
- Audi pre sense front
- Audi pre sense rear

In addition, these last functions are extended by a maximum deceleration action by Audi pre sense. The systems in the assistance package complement each other and provide mutual assistance. See the description of the respective assistance system for information on activation or adjustment.



**Audi active lane assist<sup>1</sup>** helps you to keep in lane by means of gentle steering intervention. The lane compliance assistant is triggered when the driver starts to cross detected lane markings without activating an indicator. The system provides assistance between speeds of around 60 and 250 km/h. Steering vibration can be adjusted if the driver wants; additional display in the head-up display; activated via a button on the steering column stalk of the indicator.

In conjunction with the optional Audi side assist including Audi pre sense rear, a noticeable corrective steering movement additionally occurs prior to leaving the lane if a lane change is rated particularly critical due to a vehicle approaching from behind. This corrective steering movement occurs even if the indicator has been activated, but only if both systems are activated and ready.

**Head-up display**

Information relevant to the driver from assistance systems, navigation instructions and warnings are projected as required onto the windshield in the driver's direct field of vision. The height-adjustable head-up display provides a multicoloured display with good contrast and minimal distraction from the road.

**Night vision assistant<sup>1</sup>**

assists the driver when driving at night by displaying a thermal image of the surroundings. People and larger wild animals are highlighted in yellow in the optional driver information system. If they move or if the system determines from their position that there is a potential risk, the marking changes to red, a warning triangle appears and a warning tone is emitted.

In conjunction with any of the following lighting systems, a person is also illuminated with 3 successive brief flashes of the headlights (marking light):

- Xenon plus in combination with high-beam assist
- LED headlights in combination with high-beam assist
- Audi Matrix LED headlights

Additional display of warnings in the optional head-up display; activated via button next to the light switch

**Camera-based speed limit display<sup>1, 2</sup>**

Recognition and display of speed limits, including temporary speed limit displays; a situational evaluation is carried out when driving in the wet, when there are speed limits for certain times of the day, or when towing a trailer<sup>3</sup>; if a sign has not been recognised by the camera, the speed limit taken from the current navigation data is displayed via Audi connect; additional display in the head-up display. The system simply provides information and does not intervene or provide a warning if the displayed speed is exceeded.

## | Driving dynamics/brakes

**Audi drive select**

changes vehicle characteristics, e.g. by adapting power steering assistance, engine characteristics and gear changing characteristics, and adaptive air suspension (optional); modes available: comfort, dynamic, auto, efficiency and individual. The system also influences other optional equipment. The efficiency mode switches the engine, transmission, adaptive cruise control (optional) or cruise control (optional) and climate control into a consumption-optimised basic setting.

**Sport suspension**

more direct contact with the road and sportier handling compared to the standard dynamic suspension thanks to a body lowered by 20 mm and stiffer springs and damper tuning

**S line sport suspension**

more dynamic suspension tuning and vehicle lowered by 10 mm compared to sport suspension or 30 mm compared to standard dynamic suspension

**adaptive air suspension**

automatically regulates the vehicle height and damping via electronically controlled air suspension with infinitely variable adaptive damping system on all four wheels; includes level control and manual lift function; different modes selected via Audi drive select; vehicle ride height lowered by up to 30 mm depending on mode

<sup>1</sup> Please note: The systems work only within system limits and assist the driver. However, the driver remains responsible for driving the vehicle and is required to be attentive at all times.

<sup>2</sup> Only available for Western Europe. <sup>3</sup> Only applies for factory-fitted trailer towing hitch.

## | Driving dynamics/brakes

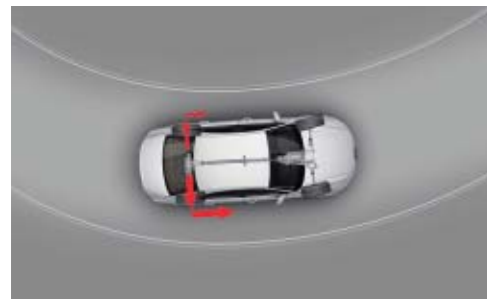
**quattro® with sport differential**

The electronically controlled sport differential distributes variable amounts of drive force to each wheel and ensures outstanding acceleration performance in bends and stabilises the vehicle's response to load change. It also improves direct steering characteristics and provides more agile handling due to the lower steering effort required.

**quattro®**

permanent all-wheel drive with self-locking centre differential and asymmetric/dynamic torque distribution, as well as wheel-selective torque control and Electronic Differential Lock (EDL) on all driven wheels; quattro emblem in the Audi Singleframe, on the luggage compartment lid and on the passenger's side of the dashboard

**6-speed manual transmission**

all-synchromesh 6-speed manual transmission with hydraulically activated single-disc dry clutch with asbestos-free linings and dual-mass flywheel

**S tronic®**

7-speed dual-clutch transmission with electrohydraulic actuation allows shorter gear-change times and gear changes with virtually no perceptible break in propulsive power. Including coasting mode in efficiency mode: when the accelerator is released the drivetrain is opened and the engine automatically switches to neutral. In automatic mode, there is a choice of programmes – D (Drive) and S (Sport). S tronic can be manually operated by means of the selector lever or the optional shift paddles behind the steering wheel.

**tiptronic**

8-speed automatic transmission with Dynamic Shift Program (DSP) and sport program; option of manual control via shift paddles on the multifunction leather steering wheel or by nudging the selector lever.

**Ceramic brake<sup>1</sup>**

19-inch high-performance brake system with carbon-fibre reinforced ceramic brake discs and high-gloss brake callipers, painted in anthracite with "Audi ceramic" logo; logo at the rear on black design trim; ventilated and perforated disc brakes with special cooling channels

**Dynamic steering**

When changing lanes, parking and cornering, this system improves comfort and handling by dynamically regulating steering according to the driving situation; in addition to adaptation of the steering effort, the steering angle is also adapted (steering ratio) up to 100% depending on the steering angle, speed and Audi drive select position. The system also supports vehicle stabilisation via ESC with lightning-fast steering responses.

## | Technology/safety

**Body, galvanised**

lightweight aluminium hybrid construction; fully galvanised in areas at risk from corrosion, self-supporting, welded to the floor pan, front and rear areas feature defined crumple zones. (12-year guarantee against rust perforation)

**Electronic Stabilisation Control (ESC) with electronic axle-differential lock**

modifies the drive forces by means of targeted braking actions, depending on the driving situation. When cornering, the electronic axle-differential lock guarantees more precise and neutral handling without understeer. Improves traction and dynamics when cornering

**Recuperation**

economises on fuel via brake energy recovery; kinetic energy is converted into usable electrical energy by increasing the generator voltage when the vehicle is coasting or braking and relieving the generator during a subsequent acceleration

**Start-stop system**

helps to reduce fuel consumption and CO<sub>2</sub> emissions by automatically switching off the engine when stationary e.g. at traffic lights. The start process is initiated as soon as the foot brake is released or the clutch is pressed (manual transmission). Can be deactivated via a switch at any time

**Audi TDI clean diesel**

In addition to the standard equipment with catalytic converter and diesel particulate filter, the exhaust aftertreatment system installed in the models with TDI clean diesel leads to lower exhaust emissions and consequently complies with the EU6 emission standard which comes into force in September 2014. This technology significantly reduces nitrogen oxides by injecting small amounts of the biodegradable additive AdBlue®<sup>2</sup> into the exhaust flow. The nitrogen oxides are then split into nitrogen and water in the nitrogen oxide catalytic converter (DeNOx catalytic converter). Refill the separate AdBlue tank as indicated by the information in the display of the instrument cluster. We recommend having the AdBlue tank refilled by your Audi partner.

**Side airbags, rear**

to supplement side airbags, front and head airbag system

**Audi exclusive seat belts<sup>3</sup>**

individual choice of colour for seat belt from the range of Audi exclusive colours.

Light Design Steering wheels/controls Comfort Infotainment Assistance systems Technology/safety Audi Extended Warranty

## | Audi Extended Warranty

**Audi Extended Warranty**

The Audi Extended Warranty provides extended risk cover and cost control beyond the first 2 years of the manufacturer's warranty for a variety of claims. It can be ordered directly and only on purchase of a new car. Choose from nine combinations of service life and mileage. For more information, please contact your Audi partner.

**ISOFIX child seat mounting and top tether for the outer rear seats**

Standard mounting for practical attachment of ISOFIX child-seat mounting, including additional fastening point (top tether).

Recommended child seats can be obtained from your Audi partner.

**ISOFIX child seat mounting for the front-passenger seat**

with passenger airbag deactivation switch; includes separate electric child-proof lock for the rear doors



## Audi Genuine Accessories. As individual as the life you lead.

Move dynamically from A to B. Not only does your Audi A6 get you where you're going, it also does so in style. Impressive moments are ensured by, among other things, Audi Genuine Accessories which give your vehicle your own personal touch. With products that emphasise your individuality and keep all our quality promises – day in, day out. Customised solutions with convincing design and functionality. Creativity in development and high production standards alongside numerous testing procedures are just as crucial for Audi Genuine Accessories as for the Audi vehicles themselves. Discover which tailor-made ideas Audi Genuine Accessories have in store for your lifestyle. A few highlights are illustrated here – please contact your Audi partner for more information on the complete range.

<sup>1</sup>Please note the special information relating to wheels on page 109.

<sup>2</sup>You will find specifications on the technical characteristics of tyres on page 113.



Detailed information can be obtained from the Audi A6 accessories catalogue, at [www.audi.com](http://www.audi.com), and from your Audi partner.

### Cast aluminium wheels in 5-tri-spoke design, anthracite, gloss turned finish<sup>1</sup>

With their elegant design and spokes in gloss turned finish, the cast aluminium wheels in size 8.5 J x 20 are particularly impressive. For tyre size 255/35 R 20.

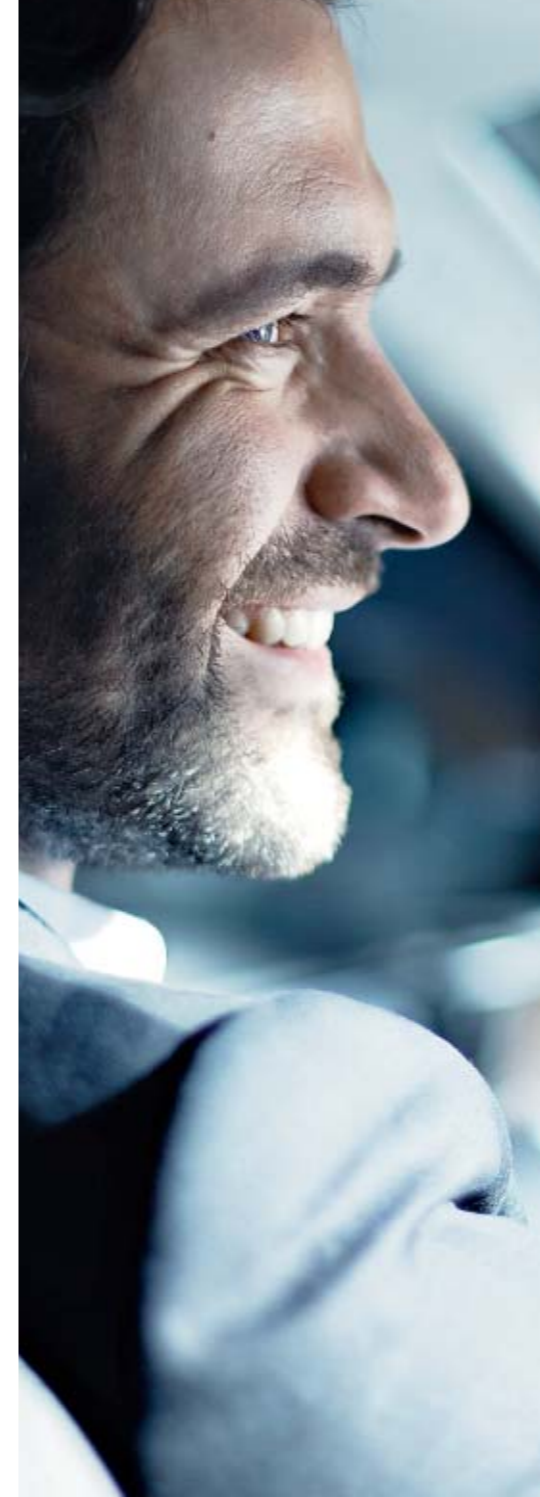

### iPad adapter

Adapter for Apple iPads for attaching to the backrests of the front seats. The adapters can be easily attached to a separately available holder for mobile devices. The operability of iPads remains unaffected. With integrated charging function and 90-degree rotation. Condition: preparation for Rear Seat Entertainment in the vehicle.



### Business case

More room for your everyday accessories. The high-quality business case offers has a volume of approx. 14 l – for a laptop up to 15 inches in size plus various office utensils. Safe attachment on the rear seat bench or on the front-passenger seat using the 3-point seat belt. Can also be used outside the vehicle as an attractive briefcase.

The fuel consumption and CO<sub>2</sub> emission figures can be found from page 104 onwards.

### Audi wireless internet access (not illustrated)

For establishing in-vehicle mobile Wi-Fi connection. Serves as a hotspot for up to 8 mobile devices such as tablets, laptops or smartphones – even up to a radius of 100 m outside the vehicle. Not limited by battery life thanks to router integrated in the vehicle. With roaming function, also for prepaid cards.

### Adapter cables for Audi music interface (not illustrated)

enable the connection of various iPod models and other portable media players to your vehicle. Can be operated via the MMI system if the function is supported by the media player. Media player charging depends on the adapter and media player used.

### Cast aluminium winter wheels in 5-V-spoke design and snow chains

Complete winter wheel in size 7.5 J x 18 with 225/55 R 18 tyre<sup>2</sup>. Also available: snow chains for improved grip on snow and ice.



**Cycle rack for the trailer towing hitch**

Cycle rack (also suitable for e-bikes) for up to 2 bicycles with a maximum load capacity of 60 kg\*. Bicycles can be locked on the rack and the rack can be locked separately on the vehicle with the same key. Moveable bicycle supports safely hold bicycles in place. Easy access to the luggage compartment thanks to practical fold-down mechanism. The bicycle rack can be folded and stored in the space-saving bag supplied. An extension set for a third bicycle is optionally available.

**Roof box bags**

Sturdy yet flexible. Includes a waterproof base with a 5-centimetre-high waterproof edge. The individual bags can be combined in different ways to make optimum use of the Audi roof boxes. Available in 3 sizes: S (43 l), M (76 l) and L (82 l).

**Ski and luggage boxes**

New Audi design with improved aerodynamics thanks to a flat, sporty look. Platinum grey roof box with brilliant black side blade and chrome-plated Audi rings; top-quality, rivet-free look. Can be locked and opened on both sides for convenient loading and unloading. With inner handle for pulling the box closed. Simple quick-attachment system including torque restriction. Position moved forward for better access to the luggage compartment. Available in 3 sizes: 300 l, 360 l and 405 l (illustrated above). Maximum permissible load 75 kg.

**Partition grille**

With the practical partition grilles (lengthways and sideways), the luggage compartment can be separated from the remaining interior and can also be divided lengthways. The partition grille is easy and convenient to attach – without any drilling. Only for the A6 Avant.

**Luggage compartment liner**

Custom-fit, washable and sturdy luggage compartment protection. Edge protects the luggage compartment floor better from leaked liquids.

**Care products (not illustrated)**

Specially tailored to the high-grade materials in your Audi. Suited for exterior maintenance or many different applications inside the vehicle, depending on the product.

**Child seat pad (not illustrated)**

Matches the design of the child seats and the vehicle interior. Protects the vehicle seats from soiling and any pressure marks caused by the child seats. With 2 practical storage bags. Can be installed with all Audi child seats, including with ISOFIX connection.

**Audi child seat**

Can be used facing forwards or backwards. With adjustable seat, integrated safety harness and adjustable head restraint. Cloth cover can be removed and washed, is breathable and gentle on the skin, certified in accordance with Oeko-Tex® standard 100. Can only be used in conjunction with the ISOFIX-Basis. Suitable for children from 9 to 18 kg (approximately 1 to 4 years). Also available: Audi child seat youngster plus for children from 15 to 36 kg (approximately 4 to 12 years) and Audi baby seat for infants up to 13 kg (approximately 12 months). All child seats are available in the colours Misano red/black and titanium grey/black.

Model	A6 1.8 TFSI (140 kW)		A6 1.8 TFSI ultra (140 kW) <sup>9</sup>		A6 2.0 TFSI (185 kW)		A6 3.0 TFSI quattro (245 kW)	
Engine type	4-cylinder inline petrol engine with direct fuel injection, turbocharging and Audi valvelift system		4-cylinder inline petrol engine with direct fuel injection, turbocharging and Audi valvelift system		4-cylinder inline petrol engine with direct fuel injection, turbocharging and Audi valvelift system		V6 petrol engine with direct fuel injection and mechanical supercharger	
Displacement in cc (valves per cylinder)	1,798 (4)		1,798 (4)		1,984 (4)		2,995 (4)	
Max. output <sup>1</sup> in kW at rpm	140/4,200–6,200		140/4,200–6,200		185/4,900–5,900		245/5,300–6,500	
Max. torque in Nm at rpm	320/1,400–4,100		320/1,400–4,100		370/1,600–4,700		440/2,900–5,300	
<b>Power transmission/wheels</b>								
Drive type	Front-wheel drive		Front-wheel drive		Front-wheel drive		quattro <sup>®</sup> permanent all-wheel drive	
Transmission type	6-speed manual transmission		7-speed S tronic		7-speed S tronic		7-speed S tronic	
Wheels	Cast aluminium wheels, 7.5 J x 16		Cast aluminium wheels, 7.5 J x 16		Forged aluminium wheels, 8 J x 17		Forged aluminium wheels, 8 J x 17	
Tyres	225/60 R 16 <sup>2</sup>		225/60 R 16 <sup>2</sup>		225/55 R 17 <sup>2</sup>		225/55 R 17 <sup>2</sup>	
<b>Weights/capacities</b>	<b>Saloon</b>	<b>Avant</b>	<b>Saloon</b>	<b>Avant</b>	<b>Saloon</b>	<b>Avant</b>	<b>Saloon</b>	<b>Avant</b>
Unladen weight <sup>3</sup> in kg	1,610	1,675	1,645	1,710	1,670	1,735	1,825	1,890
Gross vehicle weight in kg	2,115	2,230	2,150	2,265	2,175	2,290	2,360	2,445
Permissible roof load limit/nose weight in kg	100/85	100/85	100/85	100/85	100/85	100/85	100/85	100/85
Trailer load limit <sup>4</sup> in kg								
unbraked	750	750	750	750	750	750	750	750
12% gradient	1,500	1,500	1,600	1,600	1,600	1,600	2,100	2,100
8% gradient	1,700	1,700	1,800	1,800	1,800	1,800	2,100	2,100
Fuel tank capacity, approx. in l	65	65	65	65	65	65	65	65
<b>Performance/consumption<sup>5</sup></b>								
Top speed in km/h	233	226	233	225	250 <sup>6</sup>	250 <sup>6</sup>	250 <sup>6</sup>	250 <sup>6</sup>
Acceleration 0–100 km/h in s	7.9	8.2	7.9	8.2	6.7	6.9	5.1	5.3
Fuel grade	Sulphur-free super RON 95 <sup>7</sup>		Sulphur-free super RON 95 <sup>7</sup>		Sulphur-free super RON 95 <sup>7</sup>		Sulphur-free super RON 95 <sup>7</sup>	
Fuel consumption <sup>8</sup> in l/100 km								
urban	7.5	7.8	7.1	7.1	7.4	7.4	9.8	9.9
extra-urban	5.0	5.3	5.0	5.1	5.1	5.2	6.0	6.2
combined	5.9	6.2	5.7	5.9	5.9	6.0	7.4	7.6
CO <sub>2</sub> emissions <sup>8</sup> in g/km								
urban	175	180	164	166	171	173	226	230
extra-urban	116	123	115	120	117	121	140	146
combined	138	144	133	137	137	140	172	177
Emission standard	EU6	EU6	EU6	EU6	EU6	EU6	EU6	EU6

[ ] Figures in square brackets refer to S tronic. Explanation of <sup>1</sup> to <sup>11</sup> on page 109.

Model	A6 2.0 TDI ultra (110 kW) <sup>9</sup>		A6 2.0 TDI ultra (140 kW) <sup>9</sup>	
Engine type	4-cylinder inline diesel engine with common rail injection system and turbocharging		4-cylinder inline diesel engine with common rail injection system and turbocharging	
Displacement in cc (valves per cylinder)	1,968 (4)		1,968 (4)	
Max. output <sup>1</sup> in kW at rpm	110/3,000–4,200		140/3,800–4,200	
Max. torque in Nm at rpm	350/1,500–3,000		400/1,750–3,000	
<b>Power transmission/wheels</b>				
Drive type	Front-wheel drive		Front-wheel drive	
Transmission type	6-speed manual transmission [7-speed S tronic]		6-speed manual transmission [7-speed S tronic]	
Wheels	Cast aluminium wheels, 7.5 J x 16		Cast aluminium wheels, 7.5 J x 16	
Tyres	225/60 R 16 <sup>2</sup>		225/60 R 16 <sup>2</sup>	
<b>Weights/capacities</b>	<b>Saloon</b>	<b>Avant</b>	<b>Saloon</b>	<b>Avant</b>
Unladen weight <sup>3</sup> in kg	1,700 [1,735]	1,765 [1,800]	1,700 [1,735]	1,765 [1,800]
Gross vehicle weight in kg	2,205 [2,240]	2,320 [2,355]	2,205 [2,240]	2,320 [2,355]
Permissible roof load limit/nose weight in kg	100/85 [100/85]	100/85 [100/85]	100/85 [100/85]	100/85 [100/85]
Trailer load limit <sup>4</sup> in kg				
unbraked	750 [750]	750 [750]	750 [750]	750 [750]
12% gradient	1,700 [1,800]	1,700 [1,800]	1,800 [1,800]	1,800 [1,800]
8% gradient	1,900 [2,000]	1,900 [2,000]	2,000 [2,000]	2,000 [2,000]
Fuel tank capacity, approx. in l	73 [73]	73 [73]	73 [73]	73 [73]
<b>Performance/consumption<sup>5</sup></b>				
Top speed in km/h	214 [214]	209 [209]	232 [232]	226 [226]
Acceleration 0–100 km/h in s	9.5 [9.6]	9.8 [9.9]	8.4 [8.2]	8.7 [8.5]
Fuel grade	Sulphur-free diesel <sup>10</sup>		Sulphur-free diesel <sup>10</sup>	
Fuel consumption <sup>8</sup> in l/100 km				
urban	5.2 [4.7]	5.3 [4.9]	5.2 [4.7]	5.4 [4.9]
extra-urban	3.9 [3.9]	4.0 [4.1]	3.9 [3.9]	4.0 [4.1]
combined	4.4 [4.2]	4.5 [4.4]	4.4 [4.2]	4.6 [4.4]
CO <sub>2</sub> emissions <sup>8</sup> in g/km				
urban	136 [125]	139 [129]	137 [125]	142 [129]
extra-urban	101 [102]	106 [108]	101 [102]	106 [108]
combined	114 [110]	118 [115]	114 [110]	119 [115]
Emission standard	EU6 [EU6]	EU6 [EU6]	EU6 [EU6]	EU6 [EU6]

Technical data   Dimensions   Standard/optional equipment

Model	A6 3.0 TDI clean diesel (160 kW) <sup>9</sup>		A6 3.0 TDI clean diesel quattro (160 kW) <sup>9</sup>		A6 3.0 TDI clean diesel quattro (200 kW) <sup>9</sup>		A6 3.0 TDI clean diesel quattro (235 kW) <sup>9</sup>	
Engine type	V6 diesel engine with common rail injection system and turbocharging		V6 diesel engine with common rail injection system and turbocharging		V6 diesel engine with common rail injection system and turbocharging		V6 bi-turbo diesel engine with common rail injection system	
Displacement in cc (valves per cylinder)	2,967 (4)		2,967 (4)		2,967 (4)		2,967 (4)	
Max. output <sup>1</sup> in kW at rpm	160/4,000–4,750		160/3,250–4,500		200/3,500–4,250		235/3,900–4,600	
Max. torque in Nm at rpm	400/1,250–3,750		500/1,250–3,000		580/1,500–3,250		650/1,400–2,800	
Power transmission/wheels								
Drive type	Front-wheel drive		quattro <sup>®</sup> permanent all-wheel drive		quattro <sup>®</sup> permanent all-wheel drive		quattro <sup>®</sup> permanent all-wheel drive	
Transmission type	7-speed S tronic		7-speed S tronic		7-speed S tronic		8-speed tiptronic	
Wheels	Forged aluminium wheels, 8 J x 17		Forged aluminium wheels, 8 J x 17		Forged aluminium wheels, 8 J x 17		Forged aluminium wheels, 8 J x 17	
Tyres	225/55 R 17 <sup>2</sup>		225/55 R 17 <sup>2</sup>		225/55 R 17 <sup>2</sup>		225/55 R 17 <sup>2</sup>	
Weights/capacities	Saloon	Avant	Saloon	Avant	Saloon	Avant	Saloon	Avant
Unladen weight <sup>3</sup> in kg	1,770	1,835	1,840	1,905	1,845	1,910	1,910	1,975
Gross vehicle weight in kg	2,275	2,390	2,375	2,460	2,380	2,465	2,445	2,530
Permissible roof load limit/nose weight in kg	100/85	100/85	100/85	100/85	100/85	100/85	100/85	100/85
Trailer load limit <sup>4</sup> in kg								
unbraked	750	750	750	750	750	750	750	750
12 <span> </span> % gradient	2,000	2,000	2,000	2,000	2,000	2,000	2,100	2,100
8 <span> </span> % gradient	2,100	2,100	2,100	2,100	2,100	2,100	2,100	2,100
Fuel tank capacity, approx. in l	73	73	73	73	73	73	73	73
Performance/consumption <sup>5</sup>								
Top speed in km/h	244	234	244	234	250 <sup>6</sup>	250 <sup>6</sup>	250 <sup>6</sup>	250 <sup>6</sup>
Acceleration 0–100 km/h in s	7.1	7.3	6.6	6.8	5.5	5.7	5.0	5.2
Fuel grade	Sulphur-free diesel <sup>10</sup>		Sulphur-free diesel <sup>10</sup>		Sulphur-free diesel <sup>10</sup>		Sulphur-free diesel <sup>10</sup>	
Fuel consumption <sup>8</sup> in l/100 km								
urban	5.5	5.5	5.9	6.0	5.9	6.0	7.3	7.5
extra-urban	4.3	4.4	4.6	4.8	4.6	4.8	5.3	5.5
combined	4.7	4.8	5.1	5.3	5.1	5.3	6.0	6.2
CO <sub>2</sub> emissions <sup>8</sup> in g/km								
urban	142	142	153	157	153	157	192	197
extra-urban	111	115	121	127	121	127	140	145
combined	122	125	133	138	133	138	159	164
Emission standard	EU6	EU6	EU6	EU6	EU6	EU6	EU6	EU6

Explanation of <sup>1</sup> to <sup>11</sup> on page 109.

Model	A6 allroad quattro 3.0 TFSI (245 kW)	A6 allroad quattro 3.0 TDI clean diesel (160 kW) <sup>9</sup>	A6 allroad quattro 3.0 TDI clean diesel (200 kW) <sup>9</sup>	A6 allroad quattro 3.0 TDI clean diesel (235 kW) <sup>9</sup>
Engine type	V6 petrol engine with direct fuel injection and mechanical supercharger	V6 diesel engine with common rail injection system and turbocharging	V6 diesel engine with common rail injection system and turbocharging	V6 bi-turbo diesel engine with common rail injection system
Displacement in cc (valves per cylinder)	2,995 (4)	2,967 (4)	2,967 (4)	2,967 (4)
Max. output <sup>1</sup> in kW at rpm	245/5,300–6,500	160/3,250–4,500	200/3,500–4,250	235/3,900–4,600
Max. torque in Nm at rpm	440/2,900–5,300	500/1,250–3,000	580/1,500–3,250	650/1,400–2,800
Power transmission/wheels				
Drive type	quattro <sup>®</sup> permanent all-wheel drive	quattro <sup>®</sup> permanent all-wheel drive	quattro <sup>®</sup> permanent all-wheel drive	quattro <sup>®</sup> permanent all-wheel drive
Transmission type	7-speed S tronic	7-speed S tronic	7-speed S tronic	8-speed tiptronic
Wheels	Cast aluminium wheels, 8 J x 18	Cast aluminium wheels, 8 J x 18	Cast aluminium wheels, 8 J x 18	Cast aluminium wheels, 8 J x 18
Tyres	235/55 R 18 <sup>2</sup>	235/55 R 18 <sup>2</sup>	235/55 R 18 <sup>2</sup>	235/55 R 18 <sup>2</sup>
Weights/capacities				
Unladen weight <sup>3</sup> in kg	1,945	1,965	1,970	2,030
Gross vehicle weight in kg	2,505	2,520	2,525	2,585
Permissible roof load limit/nose weight in kg	100/100	100/100	100/100	100/100
Trailer load limit <sup>4</sup> in kg				
unbraked	750	750	750	750
12 <span> </span> % gradient	2,500	2,500	2,500	2,500
8 <span> </span> % gradient	2,500	2,500	2,500	2,500
Fuel tank capacity, approx. in l	65	73	73	73
Performance/consumption <sup>5</sup>				
Top speed in km/h	250 <sup>6</sup>	227	250 <sup>6</sup>	250 <sup>6</sup>
Acceleration 0–100 km/h in s	5.8	7.3	6.2	5.5
Fuel grade	Sulphur-free super RON 95 <sup>7</sup>	Sulphur-free diesel <sup>10</sup>	Sulphur-free diesel <sup>10</sup>	Sulphur-free diesel <sup>10</sup>
Fuel consumption <sup>8</sup> in l/100 km				
urban	10.1	6.4	6.4	7.7
extra-urban	6.7	5.2	5.2	5.8
combined	8.0	5.6	5.6	6.5
CO <sub>2</sub> emissions <sup>8</sup> in g/km				
urban	234	168	168	203
extra-urban	156	138	138	154
combined	185	149	149	172
Emission standard	EU6	EU6	EU6	EU6

<b>Model</b>	<b>S6 Saloon 4.0 TFSI quattro (331 kW)<sup>11</sup></b>	<b>S6 Avant 4.0 TFSI quattro (331 kW)<sup>11</sup></b>
Engine type	V8 bi-turbo petrol engine with direct fuel injection, Audi valvelift system and Audi cylinder on demand	V8 bi-turbo petrol engine with direct fuel injection, Audi valvelift system and Audi cylinder on demand
Displacement in cc (valves per cylinder)	3,993 (4)	3,993 (4)
Max. output <sup>3</sup> in kW at rpm	331/5,800–6,400	331/5,800–6,400
Max. torque in Nm at rpm	550/1,400–5,700	550/1,400–5,700
<b>Power transmission/wheels</b>		
Drive type	quattro® permanent all-wheel drive	quattro® permanent all-wheel drive
Transmission type	7-speed S tronic	7-speed S tronic
Wheels	Cast aluminium wheels in 5-parallel-spoke design (S design), 8.5 J x 19	Cast aluminium wheels in 5-parallel-spoke design (S design), 8.5 J x 19
Tyres	255/40 R 19 <sup>2</sup>	255/40 R 19 <sup>2</sup>
<b>Weights/capacities</b>		
Unladen weight <sup>3</sup> in kg	1,970	2,035
Gross vehicle weight in kg	2,505	2,590
Permissible roof load limit/nose weight in kg	100/85	100/85
Trailer load limit <sup>4</sup> in kg		
unbraked	750	750
12 <span> </span> % gradient	2,100	2,100
8 <span> </span> % gradient	2,100	2,100
Fuel tank capacity, approx. in l	75	75
<b>Performance/consumption<sup>5</sup></b>		
Top speed in km/h	250 <sup>6</sup>	250 <sup>6</sup>
Acceleration 0–100 km/h in s	4.4	4.6
Fuel grade	Sulphur-free super RON 95 <sup>7</sup>	Sulphur-free super RON 95 <sup>7</sup>
Fuel consumption <sup>8</sup> in l/100 km		
urban	13.1	13.4
extra-urban	6.9	7.1
combined	9.2	9.4
CO <sub>2</sub> emissions <sup>8</sup> in g/km		
urban	305	309
extra-urban	162	167
combined	214	219
Emission standard	EU6	EU6

### Explanatory notes

<sup>1</sup> The figure given was calculated using the specified measuring procedure (current version of UN-R 85).

<sup>2</sup> You will find specifications on the technical characteristics of tyres on page 113.

<sup>3</sup> Unladen vehicle weight includes driver (75 kg) and fuel tank 90 % full, calculated in accordance with the current version of Reg. (EU) 1230/2012. Optional equipment may increase the car's unladen weight and drag coefficient, whereupon the possible payload limit and the top speed will be reduced accordingly.

<sup>4</sup> The engine's power output always decreases with increasing altitude. At 1,000 m above sea level, and for every additional 1,000 m, deduct 10 % from the weight of the outfit (trailer load limit + gross weight of the towing vehicle). Figure for trailer load limit applies to factory-fitted trailer towing hitch. If using the vehicle with a trailer towing hitch for commercial purposes, a digital tachograph may be required under certain conditions.

<sup>5</sup> A vehicle's fuel consumption and CO<sub>2</sub> emissions and deviations from the figures given do not just depend on how efficiently the vehicle uses the fuel, but are also influenced by driving behaviour and other non-technical factors. The figures given for fuel consumption and CO<sub>2</sub> emissions refer to each illustrated standard wheel/tyre combination and may change depending on different wheel or tyre dimensions selected. CO<sub>2</sub> is the greenhouse gas primarily responsible for global warming.

<sup>6</sup> Regulated.

<sup>7</sup> We recommend using sulphur-free super unleaded RON 95 fuel complying with DIN EN 228. If this is not available, use sulphur-free regular unleaded RON 91 fuel complying with DIN EN 228; power output will be slightly reduced. Unleaded RON 95 fuel with a maximum ethanol content of 10 % (E10) can generally be used. Fuel consumption details refer to operation with RON 95 fuel complying with 692/2008/EC.

<sup>8</sup> The figures given were calculated using the specified measuring procedures. The figures do not refer to one individual vehicle and do not form part of any offer, but rather should be used purely for purposes of comparison between the different vehicle models.

<sup>9</sup> Refill the separate AdBlue® tank as indicated by the information in the display of the instrument cluster. We recommend having the AdBlue tank refilled by your Audi partner.

<sup>10</sup> We recommend using sulphur-free diesel complying with DIN EN 590. If this is not available, use diesel complying with DIN EN 590.

<sup>11</sup> For information on when this feature will be available, please contact your Audi partner.

### Important note

**Special information about the wheels:** wheels with gloss turned finish as well as polished or partly polished aluminium wheels must not be used in wintry road conditions. For manufacturing reasons, the rim surface does not have sufficient corrosion protection for such use and can be damaged permanently by road salt or similar.

Audi A6 Saloon

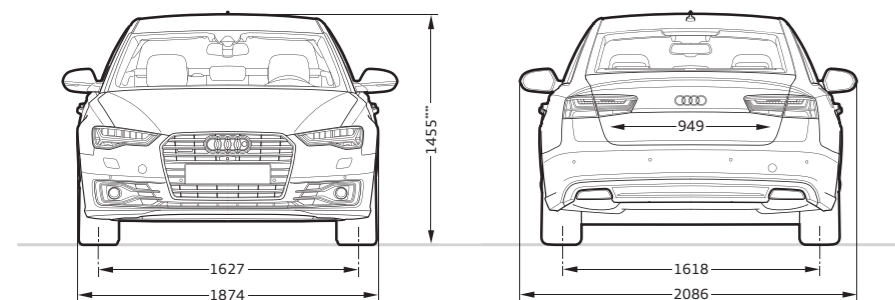
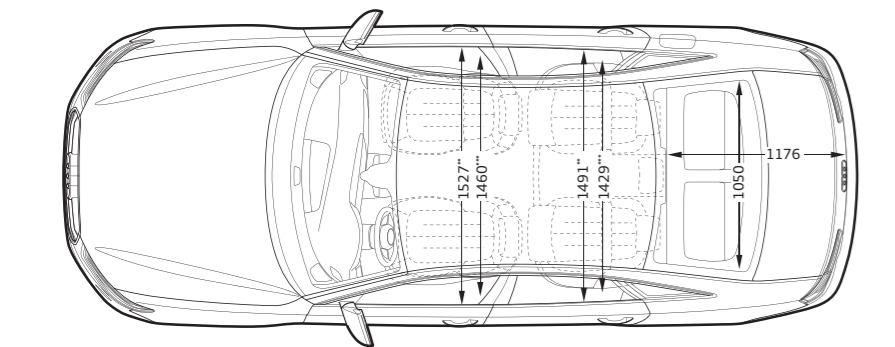
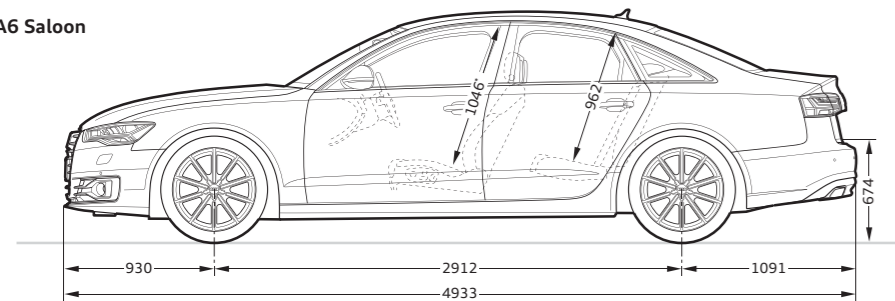
**Dimensions in millimetres.**

Dimensions were measured with vehicle at unladen weight.

Luggage compartment volume 530/995 l (second value: with the rear seat backrest folded down).

Turning circle approx. 11.9 m.

\*Maximum headroom. \*\*Elbow room width. \*\*\*Shoulder room width. \*\*\*\*With roof aerial the height of the vehicle is 1,468 mm.

Audi A6 Avant

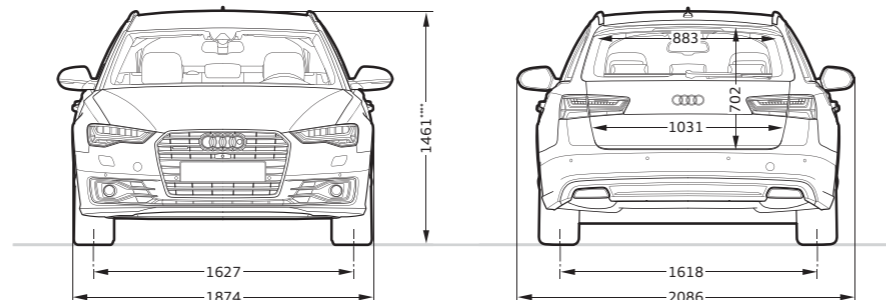
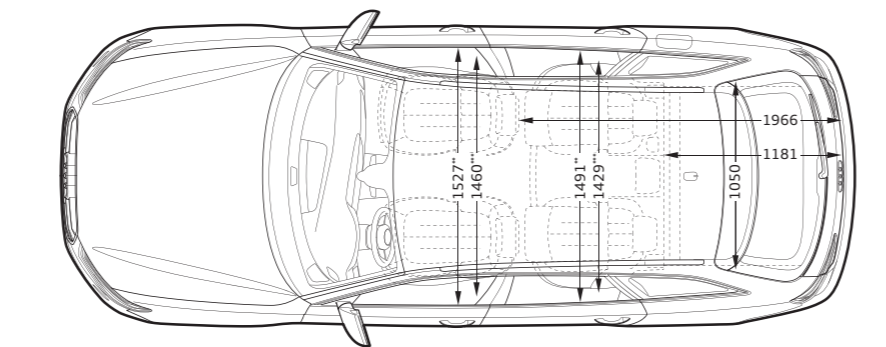
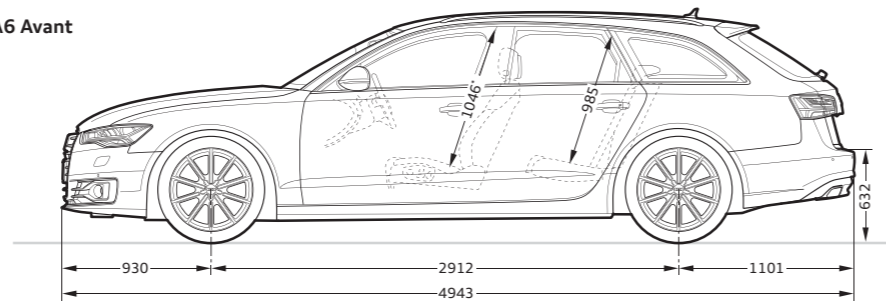
**Dimensions in millimetres.**

Dimensions were measured with vehicle at unladen weight.

Luggage capacity 565/1,680 l (second value with the rear seat backrest folded down and vehicle loaded up to roof height).

Turning circle approx. 11.9 m.

\*Maximum headroom. \*\*Elbow room width. \*\*\*Shoulder room width. \*\*\*\*With roof aerial the height of the vehicle is 1,482 mm.

Audi S6 Saloon

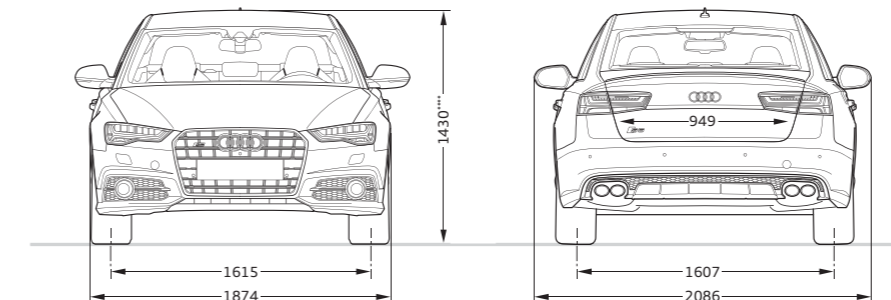
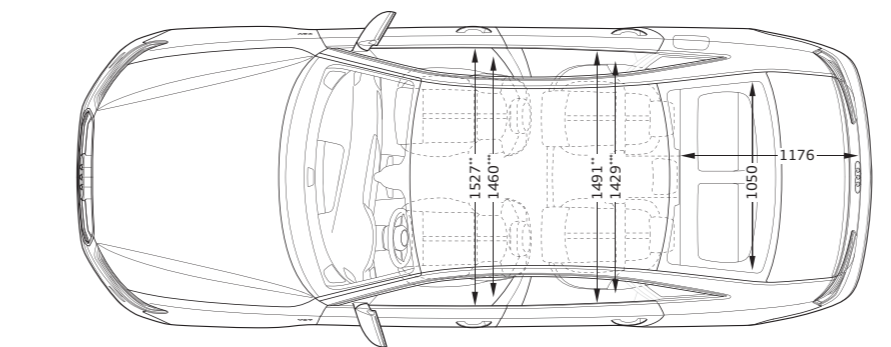
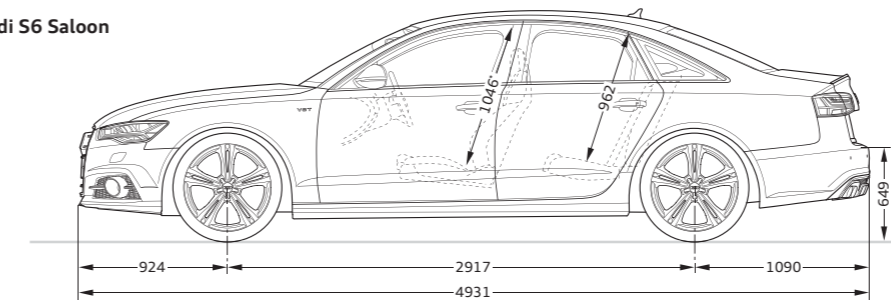
**Dimensions in millimetres.**

Dimensions were measured with vehicle at unladen weight, ground clearance measured with vehicle carrying its maximum load.

Luggage capacity 530/995 l (second value with the rear seat backrest folded down and vehicle loaded up to roof height).

Turning circle approx. 11.9 m.

\*Maximum headroom. \*\*Elbow room width. \*\*\*Shoulder room width. \*\*\*\*With roof aerial the height of the vehicle is 1,468 mm.

Audi S6 Avant

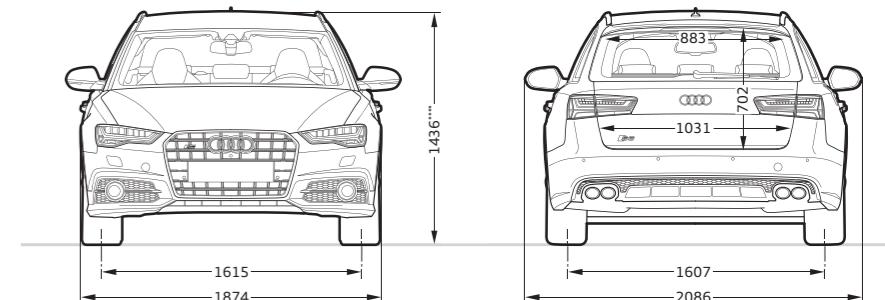
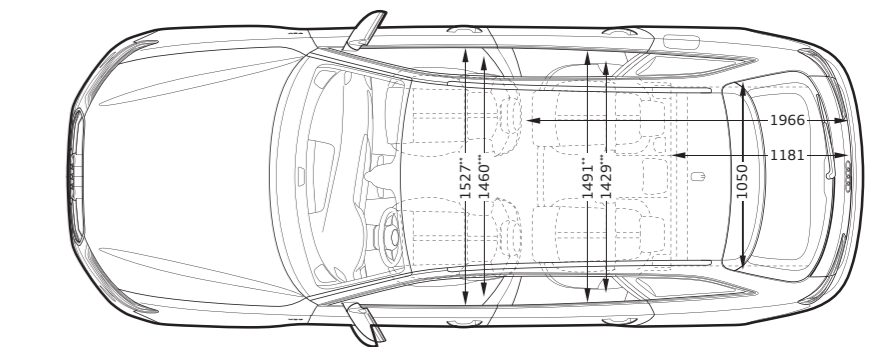
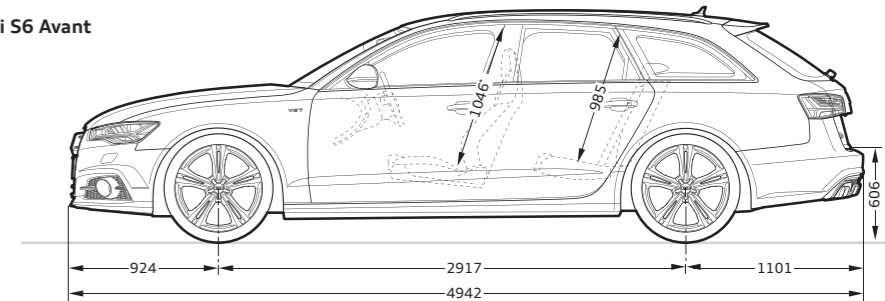
**Dimensions in millimetres.**

Dimensions were measured with vehicle at unladen weight, ground clearance measured with vehicle carrying its maximum load.

Luggage capacity 565/1,680 l (second value with the rear seat backrest folded down and vehicle loaded up to roof height).

Turning circle approx. 11.9 m.

\*Maximum headroom. \*\*Elbow room width. \*\*\*Shoulder room width. \*\*\*\*With roof aerial the height of the vehicle is 1,482 mm.



## Audi A6 allroad quattro

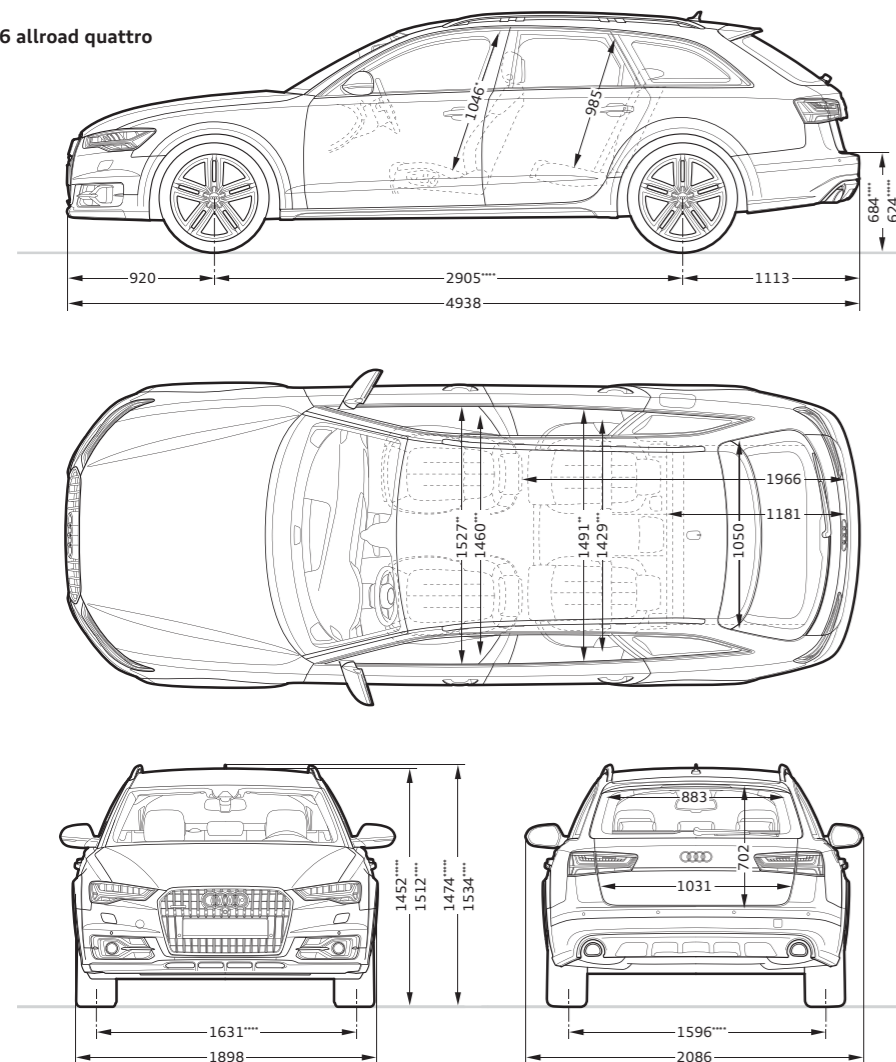

## Dimensions in millimetres.

Dimensions were measured with vehicle at unladen weight, ground clearance measured with vehicle carrying its maximum load.

Luggage capacity 565/1,680 l (second value with the rear seat backrest folded down and vehicle loaded up to roof height).

Turning circle approx. 11.9 m.















\*Maximum headroom. \*\*Elbow room width. \*\*\*Shoulder room width. \*\*\*\*Lift mode. \*\*\*\*\*Dynamic mode.

## Classifications of tyre parameters

The table shows the range of fuel efficiency, wet grip and exterior noise emission classes for the different tyre sizes of the Audi A6 Saloon, A6 Avant, A6 allroad quattro, Audi S6 Saloon and S6 Avant.

	Tyre size	Fuel efficiency class	Wet grip class	Exterior noise emission class
Summer tyres	225/60 R 16	C	B	71
	225/55 R 17	E-C	C-A	72-67  -
	235/55 R 18	E	B	71
	245/45 R 18	E-C	C-A	72-68  -
	255/45 R 19	E	B	72
	255/40 R 19	E-C	C-A	73-69  -
	255/40 R 20	E-C	B	73-70  -
	255/35 R 20	E	C-B	73-72
Winter tyres	225/60 R 16	F-E	E-C	72-69  -
	225/55 R 17	E	E-C	70-68  -
	225/50 R 18	E	E-B	72-69  -
	235/55 R 18	E	E	71
	235/45 R 19	E	E-C	72-71
	255/40 R 20	C	B	73
All-season tyres	225/55 R 17	C-B	E-C	72-67  -









It is not possible to order a specific tyre. Ask your Audi partner about the range of tyres available in your country.

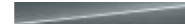







	Page	A6 Saloon	A6 Avant	A6 allroad quattro	S6 Saloon	S6 Avant
<b>Lines and packages</b>	<b>66</b>					
S line exterior package		■	■	—	—	—
S line sport package		■	■	—	—	—
Audi design selection flint grey		■	■	■	—	—
Audi design selection Arras red		—	—	—	■	■
<b>Audi exclusive</b>	<b>70</b>					
Audi exclusive line		■	■	■	—	—
<b>Solid paint finishes</b>	<b>74</b>					
 Ibis white		□	□	□	□	□
 Brilliant black		□	□	□	□	□
<b>Metallic paint finishes</b>	<b>74</b>					
 Glacier white, metallic		■	■	■	■	■
 Floret silver, metallic		■	■	■	■	■
 Tornado grey, metallic		■	■	■	■	■
 Oolong grey, metallic		■	■	■	■	■
 Dakota grey, metallic		■	■	■	—	—
 Havana black, metallic		■	■	■	■	■
 Mythos black, metallic		■	■	■	■	■
 Aviator blue, metallic		■	■	—	—	—
 Moonlight blue, metallic		■	■	■	■	■
 Carat beige, metallic		■	■	■	■	■
 Java brown, metallic		—	—	■	—	—
<b>Pearl effect paint finishes</b>	<b>75</b>					
 Misano red, pearl effect		■ <sup>1</sup>	■ <sup>1</sup>	—	■	■
 Garnet red, pearl effect		■	■	■	—	—









□ Standard equipment ■ Optional equipment — Not available

Country-specific variations possible. Please find out from your local Audi partner which equipment is standard and what optional equipment is available in your country.





More detailed descriptions of a selection of items from the equipment range can be found from page 54 onwards.

	Page	A6 Saloon	A6 Avant	A6 allroad quattro	S6 Saloon	S6 Avant
 Daytona grey, pearl effect		■ <sup>2</sup>	■ <sup>2</sup>	—	■	■
 Sepang blue, pearl effect		—	—	—	■	■
<b>Customised paint finishes</b>	<b>75</b>					
 Audi exclusive customised paint finishes		■	■	■	■	■
<b>Contrasting/full paint finishes</b>	<b>75</b>					
Contrasting paint finish		—	—	□	—	—
Full paint finish		—	—	■	—	—
<b>Wheels/tyres</b>	<b>76</b>					
 16" cast aluminium wheels in 7-arm design		□	□	—	—	—
 17" forged aluminium wheels in 6-arm design		□	□	—	—	—
 17" cast aluminium wheels in 10-spoke design		■	■	—	—	—
 18" cast aluminium wheels in 5-arm design		—	—	□	—	—
 18" cast aluminium wheels in 10-spoke V design		■	■	—	—	—
 18" cast aluminium wheels in 5-V-spoke design		■	■	—	—	—

	Page	A6 Saloon	A6 Avant	A6 allroad quattro	S6 Saloon	S6 Avant
 18" Audi Sport cast aluminium wheels in 5-twin-spoke design		■	■	—	—	—
 18" Audi Sport cast aluminium wheels in 7-twin-spoke design		■	■	—	—	—
 19" cast aluminium wheels in 10-spoke design		—	—	■	—	—
 19" cast aluminium wheels in 15-spoke star design		■	■	—	—	—
 19" cast aluminium wheels in 5-parallel-spoke design (S design)		—	—	—	□	□
 19" Audi Sport cast aluminium wheels in 10-Y-spoke design		■	■	■	■	■
 19" Audi Sport cast aluminium wheels in 10-spoke design		■	■	■	■	■
 19" Audi Sport cast aluminium wheels in 10-spoke design in matt titanium look, gloss turned finish <sup>3</sup>		■	■	■	■	■
 19" Audi Sport cast aluminium wheels in 5-twin-spoke design		■	■	—	■	■

	Page	A6 Saloon	A6 Avant	A6 allroad quattro	S6 Saloon	S6 Avant
 20" forged aluminium wheels in 5-arm star design, contrasting grey, partly polished <sup>3</sup>		■	■	—	—	—
 20" cast aluminium wheels in 5-parallel-spoke design		—	—	■	—	—
 20" cast aluminium wheels in 5-parallel-spoke star design (S design)		—	—	—	■	■
 20" Audi Sport cast aluminium wheels in 5-arm rotor design in matt titanium look, gloss turned finish <sup>3</sup>		■	■	—	■	■
 20" Audi Sport cast aluminium wheels in 5-twin-spoke design		■	■	■	■	■
 20" Audi Sport cast aluminium wheels in 5-twin-spoke design in matt titanium look, gloss turned finish <sup>3</sup>		■	■	■	■	■
 16" cast aluminium winter wheels in 7-arm design		■	■	—	—	—
 17" cast aluminium winter wheels in 6-arm design		■	■	—	—	—
 18" cast aluminium winter wheels in 5-arm design		■	■	—	—	—













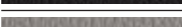
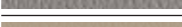

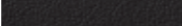

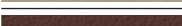
<sup>1</sup> Only available in conjunction with S line exterior package. <sup>2</sup> Only available in conjunction with S line exterior package or S line sport package. <sup>3</sup> Please note the special information relating to wheels on page 109.



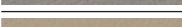
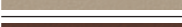









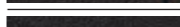
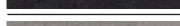



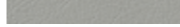

	Page	A6 Saloon	A6 Avant	A6 allroad quattro	S6 Saloon	S6 Avant
<b>Wheels/tyres (continued)</b>	<b>76</b>					
 18" cast aluminium winter wheels in 5-arm design		—	—	■	—	—
 19" cast aluminium winter wheels in 15-spoke star design		■	■	—	■	■
 20" cast aluminium winter wheels in 5-parallel-spoke design		—	—	■	—	—
 20" cast aluminium winter wheels in 5-parallel-spoke star design (S design)		—	—	—	■	■
Tyre repair kit		□	□	□	□	□
Spare wheel, space-saving		■	■	—	■	■
Collapsible spare wheel		—	—	■	—	—
Tyre pressure loss indicator		□	□	□	□	□
Anti-theft wheel bolts		■	■	■	■	■
Vehicle tool kit		□	□	□	—	—
Vehicle jack		■	■	■	■	■
<b>Seats</b>	<b>78</b>					
Standard seats, front		□	□	□	■	■
Individual contour seats, front		■	■	■	■	■
Sport seats, front		■	■	■	□	□
S sport seats, front		■ <sup>1</sup>	■ <sup>1</sup>	—	■	■

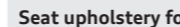
□ Standard equipment ■ Optional equipment — Not available

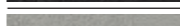
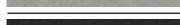
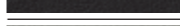
Country-specific variations possible. Please find out from your local Audi partner which equipment is standard and what optional equipment is available in your country.







More detailed descriptions of a selection of items from the equipment range can be found from page 54 onwards.



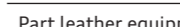
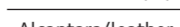
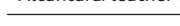
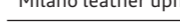
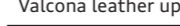

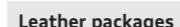
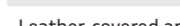

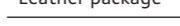
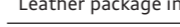

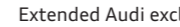
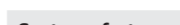
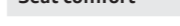
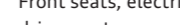
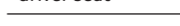
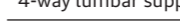
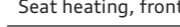
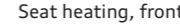



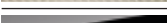

	Page	A6 Saloon	A6 Avant	A6 allroad quattro	S6 Saloon	S6 Avant
<b>Seat upholstery for standard seats, front</b>	<b>82</b>					
 Effect cloth, black		□	□	—	—	—
 Sierra cloth/mono.pur 350		—	—	□	—	—
 Part leather, black <sup>2</sup>		■	■	—	—	—
 Part leather, flint grey <sup>2</sup>		■	■	—	—	—
 Part leather, Atlas beige <sup>2</sup>		■	■	—	—	—
 Part leather, nougat brown <sup>2</sup>		■	■	—	—	—
 Milano leather, black <sup>2</sup>		■	■	■	—	—
 Milano leather, flint grey <sup>2</sup>		■	■	—	—	—
 Milano leather, Atlas beige <sup>2</sup>		■	■	■	—	—
 Milano leather, nougat brown <sup>2</sup>		■	■	—	—	—
 Milano leather, Santos brown <sup>2</sup>		—	—	■	—	—
 Audi exclusive leather upholstery and trim <sup>2</sup>		■	■	■	■	■
<b>Seat upholstery for individual seats, front</b>	<b>82</b>					
 Valcona leather, black <sup>2</sup>		■	■	■	■	■
 Valcona leather, flint grey <sup>2</sup>		■	■	■	■	■
 Valcona leather, Atlas beige <sup>2</sup>		■	■	■	—	—
 Valcona leather, nougat brown <sup>2</sup>		■	■	—	—	—
 Valcona leather, Santos brown <sup>2</sup>		—	—	■	—	—
 Valcona leather, flint grey with contrasting stitching		■ <sup>3</sup>	■ <sup>3</sup>	■ <sup>3</sup>	—	—
 Valcona leather, alabaster white		■ <sup>4</sup>	■ <sup>4</sup>	■ <sup>4</sup>	—	—
 Audi exclusive leather upholstery and trim <sup>2</sup>		■	■	■	■	■
<b>Seat upholstery for sport seats, front</b>	<b>82</b>					
 Contour cloth, black		■	■	—	—	—
 Sequence cloth/leather, black with contrasting stitching		■ <sup>1</sup>	■ <sup>1</sup>	—	—	—

	Page	A6 Saloon	A6 Avant	A6 allroad quattro	S6 Saloon	S6 Avant
 Milano leather, black		■	■	—	—	—
 Milano leather, black with contrasting stitching		—	—	■	—	—
 Alcantara/leather, black		■	■	■	□	□
 Alcantara/leather, flint grey		■	■	—	—	—
 Perforated Alcantara/leather, black with contrasting stitching		■ <sup>1</sup>	■ <sup>1</sup>	—	—	—
 Valcona leather, black		■	■	—	—	—
 Valcona leather, lunar silver		■ <sup>1</sup>	■ <sup>1</sup>	—	—	—
 Valcona leather, flint grey		■	■	—	—	—
 Valcona leather, nougat brown		■	■	—	—	—
 Valcona leather, black with contrasting stitching		—	—	■	—	—
 Valcona leather, Atlas beige with contrasting stitching		—	—	■	—	—
 Valcona leather, Santos brown with contrasting stitching		—	—	■	—	—
 Audi exclusive leather upholstery and trim		■	■	■	■	■
<b>Seat upholstery for S sport seats, front</b>	<b>82</b>					
 Alcantara/leather, black		—	—	—	□	□
 Alcantara/leather, lunar silver		—	—	—	□	□
 Valcona leather, black		■ <sup>1</sup>	■ <sup>1</sup>	—	—	—
 Valcona leather, lunar silver		■ <sup>1</sup>	■ <sup>1</sup>	—	—	—
 Valcona leather, black with contrasting stitching		—	—	—	■	■
 Valcona leather, lunar silver with contrasting stitching		—	—	—	■	■
 Valcona leather, Arras red with contrasting stitching		—	—	—	■ <sup>3</sup>	■ <sup>3</sup>
 Audi exclusive leather upholstery and trim		■	■	—	■	■
<b>Cloth and leather upholstery and trim</b>	<b>81</b>					
 Effect cloth upholstery and trim		□	□	—	—	—
 Contour cloth upholstery and trim		■	■	—	—	—

<sup>1</sup> Only available in conjunction with S line sport package. <sup>2</sup> In conjunction with seat ventilation, front, the leather on the front and outer rear seats is perforated. <sup>3</sup> Only available in conjunction with Audi design selection.

<sup>4</sup> Only available in conjunction with Audi exclusive line.

	Page	A6 Saloon	A6 Avant	A6 allroad quattro	S6 Saloon	S6 Avant
 Sierra/mono.pur 350 cloth upholstery and trim		—	—	□	—	—
 Part leather equipment		■	■	—	—	—
 Alcantara/leather combination		■	■	■	□	□
 Milano leather upholstery and trim		■	■	■	—	—
 Valcona leather upholstery and trim		■	■	■	■	■
 Audi exclusive leather upholstery and trim (package 1) in Valcona leather		■	■	■	■	■
 Audi exclusive leather upholstery and trim (package 2) in Valcona leather		■	■	■	■	■
 Audi exclusive leather upholstery and trim (package 1) in Alcantara/Valcona leather		■	■	■	■	■
<b>Leather packages</b>	<b>82</b>					
 Leather-covered armrests in the door trims		■	■	■	■	■
 Leather package		■	■	■	—	—
 Leather package including airbag cover		■	■	■	■	■
 Audi exclusive leather package including airbag cover		■	■	■	■	■
 Extended Audi exclusive leather package		■	■	■	■	■
 Audi exclusive piping for individual contour seats		■	■	■	■	■
 Audi exclusive leather-covered seat trim		■	■	■	■	■
<b>Seat comfort</b>	<b>82</b>					
 Front seats, electrically adjustable, including memory function for the driver seat		■	■	■	□	□
 4-way lumbar support for the front seats		■	■	■	□	□
 Seat heating, front		■	■	■	■	■
 Seat heating, front and rear		■	■	■	■	■
 Seat ventilation, front		■	■	■	■	■
 Massage function, front		■	■	■	■	■
 Centre armrest, front		■	■	■	□	□

	Page	A6 Saloon	A6 Avant	A6 allroad quattro	S6 Saloon	S6 Avant
<b>Seats in the rear</b>	<b>82</b>					
Rear seat system		<input type="checkbox"/>	<input type="checkbox"/>	<input type="checkbox"/>	<input type="checkbox"/>	<input type="checkbox"/>
Rear seat backrest, folding		<input checked="" type="checkbox"/>	<input type="checkbox"/>	<input type="checkbox"/>	<input type="checkbox"/>	<input type="checkbox"/>
<b>Headlinings</b>	<b>82</b>					
Headlining in cloth		<input type="checkbox"/>	<input type="checkbox"/>	<input type="checkbox"/>	<input type="checkbox"/>	<input type="checkbox"/>
Headlining in cloth, black		<input type="checkbox"/> <sup>1</sup>	<input type="checkbox"/> <sup>1</sup>	<input checked="" type="checkbox"/>	<input checked="" type="checkbox"/>	<input checked="" type="checkbox"/>
Headlining in Alcantara, black		<input checked="" type="checkbox"/>	<input checked="" type="checkbox"/>	<input checked="" type="checkbox"/>	<input checked="" type="checkbox"/>	<input checked="" type="checkbox"/>
Audi exclusive headlining in Alcantara, black, with coloured stitching		<input checked="" type="checkbox"/>	<input checked="" type="checkbox"/>	<input checked="" type="checkbox"/>	<input checked="" type="checkbox"/>	<input checked="" type="checkbox"/>
<b>Inlays</b>	<b>84</b>					
 Satin finish, silver-grey		<input type="checkbox"/>	<input type="checkbox"/>	–	–	–
 Satin finish, silver-beige		<input type="checkbox"/>	<input type="checkbox"/>	<input type="checkbox"/>	–	–
 Matt brushed aluminium		<input checked="" type="checkbox"/> <sup>2</sup>	<input checked="" type="checkbox"/> <sup>2</sup>	–	<input type="checkbox"/>	<input type="checkbox"/>
 Aluminium delta, silver		<input checked="" type="checkbox"/>	<input checked="" type="checkbox"/>	<input checked="" type="checkbox"/>	–	–
 Aluminium delta, bronze		–	–	<input checked="" type="checkbox"/>	–	–
 Piano finish, black		<input checked="" type="checkbox"/>	<input checked="" type="checkbox"/>	<input checked="" type="checkbox"/>	<input checked="" type="checkbox"/>	<input checked="" type="checkbox"/>
 Walnut, dark brown		<input checked="" type="checkbox"/>	<input checked="" type="checkbox"/>	<input checked="" type="checkbox"/>	–	–
 Eucalyptus, natural		<input checked="" type="checkbox"/> <sup>3</sup>	<input checked="" type="checkbox"/> <sup>3</sup>	<input checked="" type="checkbox"/> <sup>3</sup>	–	–
 Fine grain ash, natural brown		<input checked="" type="checkbox"/>	<input checked="" type="checkbox"/>	<input checked="" type="checkbox"/>	<input checked="" type="checkbox"/>	<input checked="" type="checkbox"/>
 Beaufort walnut		<input checked="" type="checkbox"/>	<input checked="" type="checkbox"/>	<input checked="" type="checkbox"/>	<input checked="" type="checkbox"/>	<input checked="" type="checkbox"/>
 Aluminium/Beaufort, black		<input checked="" type="checkbox"/>	<input checked="" type="checkbox"/>	<input checked="" type="checkbox"/>	<input checked="" type="checkbox"/>	<input checked="" type="checkbox"/>
 Fine grain ash, natural brass		<input checked="" type="checkbox"/> <sup>4</sup>	<input checked="" type="checkbox"/> <sup>4</sup>	<input checked="" type="checkbox"/> <sup>4</sup>	–	–
 Carbon Atlas		–	–	–	<input checked="" type="checkbox"/>	<input checked="" type="checkbox"/>
 Carbon twill, red		–	–	–	<input checked="" type="checkbox"/> <sup>4</sup>	<input checked="" type="checkbox"/> <sup>4</sup>
 Audi exclusive inlays		<input checked="" type="checkbox"/>	<input checked="" type="checkbox"/>	<input checked="" type="checkbox"/>	<input checked="" type="checkbox"/>	<input checked="" type="checkbox"/>

Standard equipment  Optional equipment  Standard/optional equipment varies by model – Not available

Country-specific variations possible. Please find out from your local Audi partner which equipment is standard and what optional equipment is available in your country.

More detailed descriptions of a selection of items from the equipment range can be found from page 54 onwards.

	Page	A6 Saloon	A6 Avant	A6 allroad quattro	S6 Saloon	S6 Avant
<b>Headlights</b>	<b>86</b>					
Xenon plus		<input type="checkbox"/>	<input type="checkbox"/>	<input type="checkbox"/>	–	–
LED headlights		<input checked="" type="checkbox"/>	<input checked="" type="checkbox"/>	<input checked="" type="checkbox"/>	<input type="checkbox"/>	<input type="checkbox"/>
Audi Matrix LED headlights		<input checked="" type="checkbox"/>	<input checked="" type="checkbox"/>	<input checked="" type="checkbox"/>	<input checked="" type="checkbox"/>	<input checked="" type="checkbox"/>
Headlight cleaning system		<input checked="" type="checkbox"/>	<input checked="" type="checkbox"/>	<input type="checkbox"/>	<input type="checkbox"/>	<input type="checkbox"/>
High-beam assist		<input checked="" type="checkbox"/>	<input checked="" type="checkbox"/>	<input checked="" type="checkbox"/>	<input checked="" type="checkbox"/>	<input checked="" type="checkbox"/>
LED rear lights with dynamic indicator		<input checked="" type="checkbox"/>	<input checked="" type="checkbox"/>	<input checked="" type="checkbox"/>	<input type="checkbox"/>	<input type="checkbox"/>
LED rear lights		<input type="checkbox"/>	<input type="checkbox"/>	<input type="checkbox"/>	<input type="checkbox"/>	<input type="checkbox"/>
Light/rain sensor		<input type="checkbox"/>	<input type="checkbox"/>	<input type="checkbox"/>	<input type="checkbox"/>	<input type="checkbox"/>
Adaptive brake light		<input type="checkbox"/>	<input type="checkbox"/>	<input type="checkbox"/>	<input type="checkbox"/>	<input type="checkbox"/>
<b>Interior lighting</b>	<b>87</b>					
Interior lighting		<input type="checkbox"/>	<input type="checkbox"/>	<input type="checkbox"/>	<input type="checkbox"/>	<input type="checkbox"/>
Interior and exterior lighting package		<input checked="" type="checkbox"/>	<input checked="" type="checkbox"/>	<input checked="" type="checkbox"/>	<input checked="" type="checkbox"/>	<input checked="" type="checkbox"/>
Ambient lighting		<input checked="" type="checkbox"/>	<input checked="" type="checkbox"/>	<input checked="" type="checkbox"/>	<input checked="" type="checkbox"/>	<input checked="" type="checkbox"/>
<b>Exterior design</b>	<b>87</b>					
Model name/logo		<input type="checkbox"/>	<input type="checkbox"/>	<input type="checkbox"/>	<input type="checkbox"/>	<input type="checkbox"/>
Roof rails		–	<input type="checkbox"/>	<input type="checkbox"/>	–	<input type="checkbox"/>
Roof edge spoiler		–	–	–	–	<input type="checkbox"/>
Rear spoiler		–	–	–	<input type="checkbox"/>	–
Exhaust tailpipes		<input type="checkbox"/>	<input type="checkbox"/>	<input type="checkbox"/>	<input type="checkbox"/>	<input type="checkbox"/>
Sport exhaust system		–	–	–	<input checked="" type="checkbox"/>	<input checked="" type="checkbox"/>
Aluminium-look exterior		–	–	<input checked="" type="checkbox"/>	–	–
Gloss package		<input type="checkbox"/>	<input type="checkbox"/>	–	<input type="checkbox"/>	<input type="checkbox"/>
Audi exclusive black gloss package		<input checked="" type="checkbox"/>	<input checked="" type="checkbox"/>	–	<input checked="" type="checkbox"/>	<input checked="" type="checkbox"/>

	Page	A6 Saloon	A6 Avant	A6 allroad quattro	S6 Saloon	S6 Avant
<b>Interior design</b>	<b>87</b>					
Velour floor mats, front		<input type="checkbox"/>	<input type="checkbox"/>	–	–	–
Velour floor mats, front and rear		<input checked="" type="checkbox"/>	<input checked="" type="checkbox"/>	<input checked="" type="checkbox"/>	<input type="checkbox"/>	<input type="checkbox"/>
Vimentum floor mats, front and rear		–	–	<input type="checkbox"/>	–	–
Audi exclusive floor mats		<input checked="" type="checkbox"/>	<input checked="" type="checkbox"/>	<input checked="" type="checkbox"/>	<input checked="" type="checkbox"/>	<input checked="" type="checkbox"/>
Audi exclusive carpet and floor mats		<input checked="" type="checkbox"/>	<input checked="" type="checkbox"/>	<input checked="" type="checkbox"/>	<input checked="" type="checkbox"/>	<input checked="" type="checkbox"/>
Pedals and footrest in stainless steel		<input type="checkbox"/> <sup>2</sup>	<input type="checkbox"/> <sup>2</sup>	–	<input type="checkbox"/>	<input type="checkbox"/>
Door sill trims with aluminium inlays		<input type="checkbox"/>	<input type="checkbox"/>	<input type="checkbox"/>	<input type="checkbox"/>	<input type="checkbox"/>
<b>Steering wheels/controls</b>	<b>88</b>					
Multifunction leather steering wheel in 4-spoke design		<input type="checkbox"/>	<input type="checkbox"/>	–	–	–
Multifunction leather steering wheel in 4-spoke design with shift paddles		<input type="checkbox"/> <sup>5</sup>	<input type="checkbox"/> <sup>5</sup>	–	–	–
Multifunction leather steering wheel in 4-spoke design, heated		<input checked="" type="checkbox"/>	<input checked="" type="checkbox"/>	–	–	–
Multifunction sport leather steering wheel in 3-spoke design		<input checked="" type="checkbox"/>	<input checked="" type="checkbox"/>	<input type="checkbox"/>	–	–
Multifunction sport leather steering wheel in 3-spoke design with shift paddles		<input checked="" type="checkbox"/>	<input checked="" type="checkbox"/>	<input checked="" type="checkbox"/>	<input type="checkbox"/>	<input type="checkbox"/>
Multifunction sport leather steering wheel in 3-spoke design with shift paddles, heated		<input checked="" type="checkbox"/>	<input checked="" type="checkbox"/>	<input checked="" type="checkbox"/>	<input checked="" type="checkbox"/>	<input checked="" type="checkbox"/>
Electric steering wheel adjustment		<input checked="" type="checkbox"/>	<input checked="" type="checkbox"/>	<input checked="" type="checkbox"/>	<input checked="" type="checkbox"/>	<input checked="" type="checkbox"/>
Steering wheel rim with wooden segments		<input checked="" type="checkbox"/>	<input checked="" type="checkbox"/>	<input checked="" type="checkbox"/>	–	–
Audi exclusive steering wheel rim with wooden segments		<input checked="" type="checkbox"/>	<input checked="" type="checkbox"/>	<input checked="" type="checkbox"/>	–	–
Audi exclusive leather steering wheel rim		<input checked="" type="checkbox"/>	<input checked="" type="checkbox"/>	<input checked="" type="checkbox"/>	<input checked="" type="checkbox"/>	<input checked="" type="checkbox"/>
Audi exclusive leather controls		<input checked="" type="checkbox"/>	<input checked="" type="checkbox"/>	<input checked="" type="checkbox"/>	<input checked="" type="checkbox"/>	<input checked="" type="checkbox"/>
Gear/selector lever knob in leather		<input type="checkbox"/>	<input type="checkbox"/>	–	–	–
Audi exclusive aluminium gear lever knob		<input checked="" type="checkbox"/>	<input checked="" type="checkbox"/>	–	–	–
Selector lever knob in aluminium look		–	–	–	<input type="checkbox"/>	<input type="checkbox"/>

<sup>1</sup> Standard in conjunction with S line sport package. <sup>2</sup> Only available in conjunction with S line sport package. <sup>3</sup> Only available in conjunction with Audi exclusive line. <sup>4</sup> Only available in conjunction with Audi design selection.

<sup>5</sup> Standard for A6 3.0 TDI clean diesel quattro (235 kW).

	Page	A6 Saloon	A6 Avant	A6 allroad quattro	S6 Saloon	S6 Avant
<b>Mirrors</b>	<b>88</b>					
Exterior mirrors with integrated LED indicator		<input type="checkbox"/>	<input type="checkbox"/>	<input type="checkbox"/>	<input type="checkbox"/>	<input type="checkbox"/>
Exterior mirrors, electrically folding		<input checked="" type="checkbox"/>	<input checked="" type="checkbox"/>	<input checked="" type="checkbox"/>	<input checked="" type="checkbox"/>	<input checked="" type="checkbox"/>
Exterior mirrors, automatically dimming on both sides		<input checked="" type="checkbox"/>	<input checked="" type="checkbox"/>	<input checked="" type="checkbox"/>	<input checked="" type="checkbox"/>	<input checked="" type="checkbox"/>
Exterior mirrors, electrically folding and automatically dimming on both sides		<input checked="" type="checkbox"/>	<input checked="" type="checkbox"/>	<input checked="" type="checkbox"/>	<input checked="" type="checkbox"/>	<input checked="" type="checkbox"/>
Exterior mirror housings in aluminium look		–	–	–	<input type="checkbox"/>	<input type="checkbox"/>
Interior mirror, manually dimming		<input type="checkbox"/>	<input type="checkbox"/>	<input type="checkbox"/>	<input type="checkbox"/>	<input type="checkbox"/>
Interior mirror automatically dimming		<input checked="" type="checkbox"/>	<input checked="" type="checkbox"/>	<input checked="" type="checkbox"/>	<input checked="" type="checkbox"/>	<input checked="" type="checkbox"/>
<b>Roof systems</b>	<b>89</b>					
Slide-and-tilt glass sunroof		<input checked="" type="checkbox"/>	–	–	<input checked="" type="checkbox"/>	–
Panoramic glass sunroof		–	<input checked="" type="checkbox"/>	<input checked="" type="checkbox"/>	–	<input checked="" type="checkbox"/>
<b>Glazing</b>	<b>89</b>					
Heat-insulating glass		<input type="checkbox"/>	<input type="checkbox"/>	<input type="checkbox"/>	<input type="checkbox"/>	<input type="checkbox"/>
Dark-tinted windows (privacy glazing)		<input checked="" type="checkbox"/>	<input checked="" type="checkbox"/>	<input checked="" type="checkbox"/>	<input checked="" type="checkbox"/>	<input checked="" type="checkbox"/>
Insulating/acoustic glass		<input checked="" type="checkbox"/>	<input checked="" type="checkbox"/>	<input checked="" type="checkbox"/>	<input checked="" type="checkbox"/>	<input checked="" type="checkbox"/>
Insulating/acoustic glass and dark-tinted windows (privacy glazing)		<input checked="" type="checkbox"/>	<input checked="" type="checkbox"/>	<input checked="" type="checkbox"/>	<input checked="" type="checkbox"/>	<input checked="" type="checkbox"/>
Sun visors hinged and swivel-mounted		<input type="checkbox"/>	<input type="checkbox"/>	<input type="checkbox"/>	<input type="checkbox"/>	<input type="checkbox"/>
Sunblinds		<input checked="" type="checkbox"/>	<input checked="" type="checkbox"/>	<input checked="" type="checkbox"/>	<input checked="" type="checkbox"/>	<input checked="" type="checkbox"/>
<b>Climate control</b>	<b>89</b>					
Deluxe automatic air conditioning		<input type="checkbox"/>	<input type="checkbox"/>	<input type="checkbox"/>	–	–
4-zone deluxe automatic air conditioning		<input checked="" type="checkbox"/>	<input checked="" type="checkbox"/>	<input checked="" type="checkbox"/>	<input type="checkbox"/>	<input type="checkbox"/>
Auxiliary heating/ventilation		<input checked="" type="checkbox"/>	<input checked="" type="checkbox"/>	<input checked="" type="checkbox"/>	<input checked="" type="checkbox"/>	<input checked="" type="checkbox"/>

	Page	A6 Saloon	A6 Avant	A6 allroad quattro	S6 Saloon	S6 Avant
<b>Closing systems</b>	<b>90</b>					
Remote control key		<input type="checkbox"/>	<input type="checkbox"/>	<input type="checkbox"/>	<input type="checkbox"/>	<input type="checkbox"/>
Engine start-stop button		<input type="checkbox"/>	<input type="checkbox"/>	<input type="checkbox"/>	<input type="checkbox"/>	<input type="checkbox"/>
Convenience key		–	■	■	–	■
Luggage compartment lid, automatically opening		<input type="checkbox"/>	–	–	–	–
Luggage compartment lid, electrically opening and closing		■	■	■	■	■
Convenience key including sensor-controlled release of the luggage compartment lid		■	■	–	■	■
Power-assisted door closing		■	■	■	■	■
Garage door opener (HomeLink)		■	■	■	■	■
Anti-theft alarm		■	■	■	<input type="checkbox"/>	<input type="checkbox"/>
Preparation for tracking system		■	■	■	■	■
<b>Storage/transport</b>	<b>91</b>					
Storage compartments		<input type="checkbox"/>	<input type="checkbox"/>	<input type="checkbox"/>	<input type="checkbox"/>	<input type="checkbox"/>
Storage package		■	■	■	<input type="checkbox"/>	<input type="checkbox"/>
Luggage compartment		<input type="checkbox"/>	<input type="checkbox"/>	<input type="checkbox"/>	<input type="checkbox"/>	<input type="checkbox"/>
Through-loading facility		–	–	–	<input type="checkbox"/>	<input type="checkbox"/>
Through-loading facility with removable ski/snowboard bag		■	■	■	■	■
Rail system		–	<input type="checkbox"/>	<input type="checkbox"/>	–	<input type="checkbox"/>
Load-securing kit		–	■	■	–	■
Partition net		–	<input type="checkbox"/>	<input type="checkbox"/>	–	<input type="checkbox"/>
Loading floor		–	<input type="checkbox"/>	<input type="checkbox"/>	–	<input type="checkbox"/>
Reversible mat		■	■	■	■	■
Non-smoker version		<input type="checkbox"/>	<input type="checkbox"/>	<input type="checkbox"/>	<input type="checkbox"/>	<input type="checkbox"/>
Cigarette lighter and ashtray		■	■	■	■	■
Provision for trailer towing hitch		■	■	■	■	■
Trailer towing hitch		■	■	■	■	■

Standard equipment   ■ Optional equipment   – Not available

Country-specific variations possible. Please find out from your local Audi partner which equipment is standard and what optional equipment is available in your country.

More detailed descriptions of a selection of items from the equipment range can be found from page 54 onwards.

	Page	A6 Saloon	A6 Avant	A6 allroad quattro	S6 Saloon	S6 Avant
<b>MMI®/navigation</b>	<b>91</b>					
Instrument cluster		<input type="checkbox"/>	<input type="checkbox"/>	<input type="checkbox"/>	<input type="checkbox"/>	<input type="checkbox"/>
Driver information system		<input type="checkbox"/>	<input type="checkbox"/>	<input type="checkbox"/>	–	–
Driver information system with colour display		■	■	■	<input type="checkbox"/>	<input type="checkbox"/>
Attention assist		<input type="checkbox"/>	<input type="checkbox"/>	<input type="checkbox"/>	<input type="checkbox"/>	<input type="checkbox"/>
MMI® navigation		■	■	■	■	■
MMI® navigation plus with MMI touch		■	■	■	■	■
<b>Entertainment</b>	<b>92</b>					
MMI® radio		<input type="checkbox"/>	<input type="checkbox"/>	<input type="checkbox"/>	–	–
MMI® radio plus		■	■	■	<input type="checkbox"/>	<input type="checkbox"/>
Digital Audio Broadcasting		■	■	■	■	■
Digital TV reception		■	■	■	■	■
Audi music interface		■	■	■	<input type="checkbox"/>	<input type="checkbox"/>
Adapter cable set for Audi music interface		■	■	■	■	■
Adapter cable set plus for Audi music interface		■	■	■	■	■
CD changer		■	■	■	■	■
DVD/CD Changer		■	■	■	■	■
Audi sound system		■	■	■	<input type="checkbox"/>	<input type="checkbox"/>
Bose Surround Sound		■	■	■	■	■
Bang & Olufsen Advanced Sound System		■	■	■	■	■
Preparation for Rear Seat Entertainment		■	■	■	■	■
<b>Communication</b>	<b>94</b>					
Audi connect		■	■	■	■	■
Bluetooth interface		■	■	■	<input type="checkbox"/>	<input type="checkbox"/>
Audi phone box		■	■	■	■	■

	Page	A6 Saloon	A6 Avant	A6 allroad quattro	S6 Saloon	S6 Avant
<b>Assistance systems</b>	<b>95</b>					
Hold assist		<input type="checkbox"/>	<input type="checkbox"/>	<input type="checkbox"/>	<input type="checkbox"/>	<input type="checkbox"/>
Hill descent control		–	–	<input type="checkbox"/>	–	–
Tilt angle display		–	–	<input type="checkbox"/>	–	–
Parking system plus		■	■	■	■	■
Park assist with display of surroundings		■	■	■	■	■
Reversing camera		■	■	■	■	■
360 degree cameras		■	■	■	■	■
Cruise control		■	■	■	■	■
Audi pre sense basic		■	■	■	■	■
adaptive cruise control with Stop&Go function including Audi pre sense front		■	■	■	■	■
Audi side assist including Audi pre sense rear		■	■	■	■	■
Audi active lane assist		■	■	■	■	■
Assistance package including Audi pre sense plus		■	■	■	■	■
Head-up display		■	■	■	■	■
Night vision assistant		■	■	■	■	■
Camera-based speed limit display		■	■	■	■	■
<b>Driving dynamics/brakes</b>	<b>97</b>					
Audi drive select		<input type="checkbox"/>	<input type="checkbox"/>	<input type="checkbox"/>	<input type="checkbox"/>	<input type="checkbox"/>
Sport suspension		■	■	–	–	–
S line sport suspension		■ <sup>1</sup>	■ <sup>1</sup>	–	–	–
adaptive air suspension		■	■	<input type="checkbox"/>	–	–
adaptive air suspension – sport		–	–	–	<input type="checkbox"/>	<input type="checkbox"/>
Front-wheel drive		<input type="checkbox"/> <sup>2</sup>	<input type="checkbox"/> <sup>2</sup>	–	–	–

<sup>1</sup> Only available in conjunction with S line sport package.   <sup>2</sup> The availability of your desired engine variant can be found in the technical data.   <sup>3</sup> Only for A6 3.0 TFSI quattro (245 kW) and A6 3.0 TDI clean diesel quattro (235 kW).

<sup>4</sup> Standard on vehicles with front-wheel drive.   <sup>5</sup> Only for TFSI models.   <sup>6</sup> Only for TDI models.

	Page	A6 Saloon	A6 Avant	A6 allroad quattro	S6 Saloon	S6 Avant
quattro®		<input type="checkbox"/> <sup>2</sup>	<input type="checkbox"/> <sup>2</sup>	<input type="checkbox"/>	<input type="checkbox"/>	<input type="checkbox"/>
quattro® with sport differential		■	■	■	■	■
6-speed manual transmission		<input type="checkbox"/> <sup>2</sup>	<input type="checkbox"/> <sup>2</sup>	–	–	–
S tronic®		<input type="checkbox"/> <sup>2</sup>	<input type="checkbox"/> <sup>2</sup>	<input type="checkbox"/> <sup>2</sup>	<input type="checkbox"/>	<input type="checkbox"/>
tiptronic		<input type="checkbox"/> <sup>2</sup>	<input type="checkbox"/> <sup>2</sup>	<input type="checkbox"/> <sup>2</sup>	–	–
Electromechanical power steering		<input type="checkbox"/>	<input type="checkbox"/>	<input type="checkbox"/>	<input type="checkbox"/>	<input type="checkbox"/>
Dynamic steering		■	■	■	■	■
Brake system		<input type="checkbox"/>	<input type="checkbox"/>	<input type="checkbox"/>	<input type="checkbox"/>	<input type="checkbox"/>
Brake callipers, painted black		–	–	–	<input type="checkbox"/>	<input type="checkbox"/>
Ceramic brake		■ <sup>3</sup>	■ <sup>3</sup>	–	■	■
Electromechanical parking brake		<input type="checkbox"/>	<input type="checkbox"/>	<input type="checkbox"/>	<input type="checkbox"/>	<input type="checkbox"/>
<b>Technology/safety</b>	<b>98</b>					
Body, galvanised		<input type="checkbox"/>	<input type="checkbox"/>	<input type="checkbox"/>	<input type="checkbox"/>	<input type="checkbox"/>
Audi cylinder on demand		–	–	–	<input type="checkbox"/>	<input type="checkbox"/>
Active Noise Cancellation		–	–	–	<input type="checkbox"/>	<input type="checkbox"/>
Antilock Brake System (ABS) with Electronic Brake Force Distribution (EBD)		<input type="checkbox"/>	<input type="checkbox"/>	<input type="checkbox"/>	<input type="checkbox"/>	<input type="checkbox"/>
Anti-Slip Regulation (ASR)		<input type="checkbox"/>	<input type="checkbox"/>	<input type="checkbox"/>	<input type="checkbox"/>	<input type="checkbox"/>
Electronic Differential Lock (EDL)		<input type="checkbox"/>	<input type="checkbox"/>	<input type="checkbox"/>	<input type="checkbox"/>	<input type="checkbox"/>
Electronic Stabilisation Control (ESC)		<input type="checkbox"/>	<input type="checkbox"/>	<input type="checkbox"/>	<input type="checkbox"/>	<input type="checkbox"/>
Electronic Stabilisation Control (ESC) with electronic axle-differential lock		<input type="checkbox"/> <sup>4</sup>	<input type="checkbox"/> <sup>4</sup>	–	–	–
65 l fuel tank		<input type="checkbox"/> <sup>5</sup>	<input type="checkbox"/> <sup>5</sup>	<input type="checkbox"/> <sup>5</sup>	–	–
73 l fuel tank		<input type="checkbox"/> <sup>6</sup>	<input type="checkbox"/> <sup>6</sup>	<input type="checkbox"/> <sup>6</sup>	–	–
75 l fuel tank		■ <sup>5</sup>	■ <sup>5</sup>	■ <sup>5</sup>	<input type="checkbox"/>	<input type="checkbox"/>

	Page	A6 Saloon	A6 Avant	A6 allroad quattro	S6 Saloon	S6 Avant
<b>Technology/safety</b> (continued)	<b>98</b>					
Recuperation		<input type="checkbox"/>	<input type="checkbox"/>	<input type="checkbox"/>	<input type="checkbox"/>	<input type="checkbox"/>
Start-stop system		<input type="checkbox"/>	<input type="checkbox"/>	<input type="checkbox"/>	<input type="checkbox"/>	<input type="checkbox"/>
Audi TDI clean diesel		<input type="checkbox"/> <sup>1</sup>	<input type="checkbox"/> <sup>1</sup>	<input type="checkbox"/> <sup>1</sup>	—	—
Airbags		<input type="checkbox"/>	<input type="checkbox"/>	<input type="checkbox"/>	<input type="checkbox"/>	<input type="checkbox"/>
Side airbags, front, and head airbag system		<input type="checkbox"/>	<input type="checkbox"/>	<input type="checkbox"/>	<input type="checkbox"/>	<input type="checkbox"/>
Side airbags, rear		<input checked="" type="checkbox"/>	<input checked="" type="checkbox"/>	<input checked="" type="checkbox"/>	<input checked="" type="checkbox"/>	<input checked="" type="checkbox"/>
Side impact protection in the doors		<input type="checkbox"/>	<input type="checkbox"/>	<input type="checkbox"/>	<input type="checkbox"/>	<input type="checkbox"/>
Integrated head restraint system		<input type="checkbox"/>	<input type="checkbox"/>	<input type="checkbox"/>	<input type="checkbox"/>	<input type="checkbox"/>
Safety steering column		<input type="checkbox"/>	<input type="checkbox"/>	<input type="checkbox"/>	<input type="checkbox"/>	<input type="checkbox"/>
Seat belts		<input type="checkbox"/>	<input type="checkbox"/>	<input type="checkbox"/>	<input type="checkbox"/>	<input type="checkbox"/>
Audi exclusive seat belts		<input checked="" type="checkbox"/>	<input checked="" type="checkbox"/>	<input checked="" type="checkbox"/>	<input checked="" type="checkbox"/>	<input checked="" type="checkbox"/>
Seat belt reminder		<input type="checkbox"/>	<input type="checkbox"/>	<input type="checkbox"/>	<input type="checkbox"/>	<input type="checkbox"/>
Child-proof lock for rear doors		<input type="checkbox"/>	<input type="checkbox"/>	<input type="checkbox"/>	<input type="checkbox"/>	<input type="checkbox"/>
ISOFIX child seat mounting and top tether for the outer rear seats		<input type="checkbox"/>	<input type="checkbox"/>	<input type="checkbox"/>	<input type="checkbox"/>	<input type="checkbox"/>
ISOFIX child seat mounting for the front-passenger seat		<input checked="" type="checkbox"/>	<input checked="" type="checkbox"/>	<input checked="" type="checkbox"/>	<input checked="" type="checkbox"/>	<input checked="" type="checkbox"/>
First-aid kit		<input checked="" type="checkbox"/>	<input checked="" type="checkbox"/>	<input checked="" type="checkbox"/>	<input checked="" type="checkbox"/>	<input checked="" type="checkbox"/>
Warning triangle		<input checked="" type="checkbox"/>	<input checked="" type="checkbox"/>	<input checked="" type="checkbox"/>	<input checked="" type="checkbox"/>	<input checked="" type="checkbox"/>
<b>Audi Extended Warranty</b>	<b>99</b>					
Audi Extended Warranty		<input checked="" type="checkbox"/>	<input checked="" type="checkbox"/>	<input checked="" type="checkbox"/>	<input checked="" type="checkbox"/>	<input checked="" type="checkbox"/>

Standard equipment    Optional equipment   — Not available

Country-specific variations possible. Please find out from your local Audi partner which equipment is standard and what optional equipment is available in your country.

More detailed descriptions of a selection of items from the equipment range can be found from page 54 onwards.

Equipment for the Audi A6 Saloon illustrated (p. 4–17):

Paint finish: carat beige, metallic

Wheels: forged aluminium wheels in 5-arm star design, contrasting grey, partly polished<sup>2</sup>

Seats/seat upholstery: individual contour seats in Valcona leather, flint grey with contrasting stitching

Inlays: fine grain ash, natural brass

Equipment for the Audi A6 Avant illustrated (p. 4–17):

Paint finish: glacier white, metallic

Wheels: cast aluminium wheels in 15-spoke star design

Seats/seat upholstery: individual contour seats in Valcona leather, nougat brown

Inlays: Beaufort walnut

Equipment for the Audi A6 allroad quattro illustrated (p. 18–25):

Paint finish: Java brown, metallic

Wheels: cast aluminium wheels in 5-parallel-spoke design

Seats/seat upholstery: sport seats in Valcona leather, Atlas beige with contrasting stitching

Inlays: aluminium delta, bronze

Equipment for the Audi S6 Saloon illustrated (p. 26–35):

Paint finish: Daytona grey, pearl effect

Wheels: cast aluminium wheels in 5-parallel-spoke design

Seats/seat upholstery: S sport seats in Valcona leather, Arras red with contrasting stitching

Inlays: carbon twill, red

Equipment for the Audi S6 Avant illustrated (p. 26–35):

Paint finish: Sepang blue, pearl effect

Wheels: cast aluminium wheels in 5-parallel-spoke star design

Seats/seat upholstery: S sport seats in Valcona leather, black with contrasting stitching

Inlays: aluminium/Beaufort, black

<sup>1</sup>Only for TDI-Modelle.   <sup>2</sup>Please note the special information relating to wheels on page 109.



## Responsibility

Living up to our responsibilities is a principle that is firmly anchored in Audi strategy. Alongside commercial success and international competitiveness, our responsibility toward company employees and society as a whole is a key consideration, as is protecting the environment and conserving resources. And what is true in the details – our catalogues are printed on FSC-certified paper – also holds in general: Audi develops cars that are not only sporty and emotive but also ever more efficient. In the

long run, Audi wants its products to allow CO<sub>2</sub>-neutral mobility. Seeing to it that production in Audi plants gradually becomes CO<sub>2</sub>-neutral is another aspect of our comprehensive approach. Audi is also committed to society – particularly in the fields of education, technology and social projects. At Audi, sustainability is closely linked with how we see the future: the Audi Urban Future Initiative sees Audi working with international experts to get to the root of future urban challenges and trends in mobility.

# Discover the the world of Audi.



## Audi experience

The fascination of Audi can be experienced in many different ways. Audi City in London, for example, gives you digital access to all models at their actual size and in real time. And of course it is always worth visiting one of the major motor shows. This is where Audi always presents its new models and invites you to take a look at how the future is being shaped with "Vorsprung durch Technik". Anyone interested in seeing how Audi is already putting this into practice will find fascinating insight in the "Vorsprung durch Technik" online special at [www.audi.com](http://www.audi.com). But a look back can also be rewarding: at the Audi museum mobile in Ingolstadt, history and high-tech go hand in hand. A total of 130 historic exhibits and state-



of-the-art forms of presentation make for a thrilling symbiosis. Plus, Audi driving experience allows you to live the excitement and countless possibilities of current Audi models. Here, pure driving enjoyment is combined with valuable learning effects. This is ensured by a team of specially trained and highly qualified instructors who provide practical tips to help you optimise your driving skills. All this can now also be enjoyed at the recently opened Audi driving experience center in Neuburg, near Ingolstadt. Facilities here include a circuit of up to 3.4 kilometres that features challenging combinations of bends, a 30,000 m<sup>2</sup> dynamic driving area and an offroad section where Q models can be put through their paces.



## Team spirit

Motorsport is a driving force behind the brand. For years Audi has been among the champions in various racing series, for instance the 24 Hours of Le Mans or the DTM German Touring Car Masters. The values that are crucial in many different areas of sport are also central ones for Audi: precision, passion and technology. No coincidence then that Audi has been sponsoring sporting events for

many years. In the world of winter sports, for example, Audi has been the main sponsor of the German Ski Association (DSV) for almost three decades and has also partnered 14 other national alpine teams. In football, we support national and international teams. And Audi is also a partner for the German Olympic Sports Confederation.



Choosing an Audi means choosing a brand that offers more. More individuality. More exclusivity. More fascination.

## www.audi.com

Information on all the topics mentioned above can be found on our website: [www.audi.com](http://www.audi.com).



[www.audi.com](http://www.audi.com)



[configurator.audi.com](http://configurator.audi.com)



[www.audi.com/vorsprung-durch-technik](http://www.audi.com/vorsprung-durch-technik)



[www.audi.com/driving](http://www.audi.com/driving)



[www.audi.com/cr](http://www.audi.com/cr)

## Equipment Audi A6/A6 Avant/A6 allroad quattro/S6/S6 Avant

360 degree cameras	95	Bose Surround Sound	93
4-way lumbar support for the front seats	117	Brake calliper, painted black	61, 121
6-speed manual transmission	98	Brake system	121
Active Noise Cancellation	61, 121	Bumpers, front	61
Adapter cable sets for Audi music interface	93	Camera-based speed limit display	97
adaptive air suspension	97	CD changer	93
adaptive air suspension – sport	61	Centre armrest, front	61, 82
Adaptive brake light	118	Ceramic brake	98
adaptive cruise control		Child-proof lock for rear doors	122
with Stop&Go function including		Cigarette lighter and ashtray	120
Audi pre sense front	96	Cloth and leather upholstery and trim	81
Airbags	121	Cloth upholstery and trim	81
Aluminium-look exterior	87	Collapsible spare wheel	116
Ambient lighting	87	Convenience key	90
Anti-Slip Regulation (ASR)	121	Cruise control	95
Anti-theft alarm	61, 90	Dark-tinted windows (privacy glazing)	89
Anti-theft wheel bolts	116	Deluxe automatic air conditioning	61, 89
Antilock Brake System (ABS) with Electronic Brake Force Distribution (EBD)	121	Diffuser insert, rear	61
Assistance package		Digital Audio Broadcasting	92
including Audi pre sense plus	96	Digital TV reception	93
Attention assist	120	Door sill trims with aluminium inlays	61, 87
Audi active lane assist	96	Driver information systems	61, 91
Audi connect	94	DVD/CD changer	93
Audi cylinder on demand	61, 121	Dynamic steering	61, 98
Audi design selection flint grey	68	Electric steering wheel adjustment	88
Audi design selection Arras red	61, 69	Electromechanical parking brake	121
Audi drive select	97	Electromechanical power steering	121
Audi exclusive	72, 73	Electronic Differential Lock (EDL)	121
Audi exclusive aluminium gear lever knob	88	Electronic Stabilisation Control (ESC)	98, 121
Audi exclusive carpet and floor mats	87	Engine start-stop button	61, 119
Audi exclusive leather controls	88	Exhaust tailpipes	61, 87
Audi exclusive line	70, 71	Exterior mirror housings in aluminium look	61
Audi Extended Warranty	99	Exterior mirrors	88
Audi Matrix LED headlights	86	First-aid kit	122
Audi music interface	93	Floor mats	61, 87
Audi phone box	94	Front seats, electrically adjustable, including memory function for the driver seat	61, 82
Audi pre sense basic	95	Front-wheel drive	121
Audi side assist including Audi pre sense rear	96	Fuel tank	121
Audi Singleframe	61	Garage door opener (HomeLink)	90
Audi sound system	61, 93	Gear/selector lever knob in leather	88
Audi TDI clean diesel	99	Gloss packages	87
Auxiliary heating/ventilation	90	Head-up display	96
Bang & Olufsen Advanced Sound System	93	Headlight cleaning system	118
Bluetooth interface	61, 94	Headlinings	82
Body, galvanised	98	Heat-insulating glass	89

**Equipment Audi A6/A6 Avant/A6 allroad quattro/S6/S6 Avant**

High-beam assist	86	Rail system	91
Hill descent control	95	Rear seat backrest, folding	118
Hold assist	95	Rear seat system	82
Inlays	61, 84, 85	Rear spoiler	61, 118
Instrument cluster	61, 120	Recuperation	98
Insulating/acoustic glass	89	Remote control key	119
Integrated head restraint system	122	Reversible mat	91
Interior and exterior lighting package	87	Reversing camera	95
Interior lighting	118	Roof edge spoiler	61, 118
Interior mirror	119	Roof rails	87
ISOFIX child seat mounting	99	S line exterior package	66
Leather packages	82	S line sport package	67
Leather upholstery and trim	81	S line sport suspension	97
LED headlights	61, 86	S tronic®	98
LED rear lights	86	Safety steering column	122
LED rear lights with dynamic indicator	86	Seat belt reminder	122
Light/rain sensor	118	Seat belts	99, 122
Load-securing kit	91	Seat heating	82
Loading floor	91	Seat upholstery	61, 82, 83
Luggage compartment	91	Seat ventilation, front	82
Luggage compartment lids	90	Seats	61, 78-80
Massage function, front	82	Selector lever knob in aluminium look	61, 119
MMI® navigation	92	Side airbags	99, 121
MMI® navigation plus with MMI touch	92	Side impact protection in the doors	122
MMI® radio	92	Side sill trims	61
MMI® radio plus	61, 92	Slide-and-tilt glass sunroof	89
Model name/logo	61, 87	Spare wheel, space-saving	116
Multifunction leather steering wheels		Sport exhaust system	61, 118
in 4-spoke design	88	Sport suspension	97
Multifunction sport leather steering wheels		Start-stop system	98
in 3-spoke design	61, 88	Steering wheel rims	88
Night vision assistant	97	Storage compartments	91
Non-smoker version	91	Storage package	61, 91
Paint finishes	61, 74, 75	Sun visors hinged and swivel-mounted	119
Panoramic glass sunroof	89	Sunblinds	89
Park assist with display of surroundings	95	Through-loading facilities	61, 91
Parking system plus	95	Tilt angle display	95
Part leather equipment	81	tiptronic	98
Partition net	91	Trailer towing hitch	91
Pedals and footrest in stainless steel	61, 119	Tyre pressure loss indicator	116
Power-assisted door closing	90	Tyre repair kit	116
Preparation for Rear Seat Entertainment	93	Vehicle jack	116
Preparation for tracking system	90	Vehicle tool kit	116
Provision for trailer towing hitch	91	Warning triangle	122
quattro®	61, 98	Wheels/tyres	61, 76, 77
quattro® with sport differential	61, 98	Xenon plus	86



**AUDI AG**  
85045 Ingolstadt  
www.audi.com  
Valid from September 2014

Printed in Germany  
433/1230.62.18

The models and equipment versions illustrated and described in this brochure and some of the services listed are not available in all countries. Some of the cars illustrated are equipped with optional features for which an extra charge is made. Details concerning the delivery specifications, appearance, performance, dimensions and weights, fuel consumption and running costs of the vehicle were correct to the best of our knowledge at the time of going to press. Deviations from the colours and shapes shown in the illustrations may occur. No liability is accepted for errors and printing errors. The right to introduce modifications is reserved. Not to be reproduced, including in part, without the written approval of AUDI AG.

This brochure is printed on paper made from pulp bleached without the use of chlorine.

